



**BUREAU
VERITAS**

TEST REPORT AS/NZS 4777.2

Grid connection of energy systems via inverters Part 2: Inverter requirements

Report reference number: PVAU160721N056-1-R2					
Date of issue: 2017-07-20					
Total number of pages: 134					
Testing laboratory name: Bureau Veritas Shenzhen Co., Ltd. Dongguan Branch					
Address: No. 34, Chenwulu Section, Guantai Rd., Houjie Town, Dongguan City, Guangdong 523942, China					
					
Applicant's name: Shenzhen SOFARSOLAR Co., Ltd.					
Address: 5L, Fourth Building, Antongda Industrial Park, Liuxian Avenue No.1, Xinan Street, Baoan District, Shenzhen, China.					
Test specification					
Standard.....: AS/NZS 4777.2:2015					
Certificate: Certificate of compliance					
Test report form number: AS4777_C					
Master TRF: Bureau Veritas Consumer Products Services Germany GmbH					
Test item description: Grid connected photovoltaic inverter					
Trademark.....: 					
Model / Type: SOFAR 1100TL, SOFAR 1600TL, SOFAR 2200TL, SOFAR 2700TL, SOFAR 3000TL					
Ratings	SOFAR 1100TL	SOFAR 1600TL	SOFAR 2200TL	SOFAR 2700TL	SOFAR 3000TL
Input DC Voltage [V]:	90-400, max. 450		100-480, max. 500		
MPP input DC Voltage [V]:	110-380	165-380	170-450	210-450	230-450
Input DC current [A]:	Max. 10		Max. 13		
Output AC Voltage [V]:	230, 50Hz				
Output AC current [A]:	Max. 4,5	Max. 7,0	Max. 9,5	Max. 11,5	Max. 13,0
Output power [W]:	Max. 1000	Max. 1500	Max. 2000	Max. 2500	Max. 2800

Testing Location	Bureau Veritas Shenzhen Co., Ltd. Dongguan Branch
Address	No. 34, Chenwulu Section, Guantai Rd., Houjie Town, Dongguan City, Guangdong 523942, China
Tested by (name and signature)	James Huang 
Approved by (name and signature)	Ted Wu 
Manufacturer's name	Shenzhen SOFARSOLAR Co., Ltd.
Factory address	5L, Fourth Building, Antongda Industrial Park, Liuxian Avenue No.1, Xinan Street, Baoan District, Shenzhen, China.

Document History			
Date	Internal reference	Modification / Change / Status	Revision
2016-08-26	Sean Tu	Initial report was written	0
2016-08-31	Sean Tu	- Add Inverter topology DRM mode marking - Correct the Verdicts of clause 6.3.5.3 and 6.3.5.4 - Add the deviation tests of New Zealand	1
2017-07-20	James Huang	Add the test results in table 7.3.	2
Supplementary information:			

Test items particulars	
Equipment mobility	Permanent connection
Operating condition	Continuous
Class of equipment	Class I
Protection against ingress of water ..	IP65 according to EN 60529
Mass of equipment [kg]	SOFAR 1100TL, SOFAR 1600TL: 11kg SOFAR 2200TL, SOFAR 2700TL, SOFAR 3000TL: 12kg
Test case verdicts	
Test case does not apply to the test object	N/A
Test item does meet the requirement	P(ass)
Test item does not meet the requirement	F(ail)
Testing	
Date of receipt of test item	2016-07-21
Date(s) of performance of test	2016-07-21 till 2016-08-31
General remarks:	
<p>The test result presented in this report relate only to the object(s) tested. This report shall not be reproduced, except in full, without the written approval of the applicant. "(see Annex #)" refers to additional information appended to the report. "(see appended table)" refers to a table appended to the report. Throughout this report a comma is used as the decimal separator. The unit was reviewed to AS 4777.2:2015 Grid connection of energy systems via inverters – Part 2: inverter requirements and the unit fulfils the requirements of the European EMC directive requirements. The EMC requirements of AS 4777.2 (flicker) refer to the same standards as the EMC directive; therefore the EMC report documents show the compliance.</p>	
This Test Report consists of the following documents:	
<ul style="list-style-type: none"> - Test Results - Annex No. 1 – EMC Test Report - Annex No. 2 – Pictures of the unit - Annex No. 3 – Test equipment list 	

Copy of marking plate:

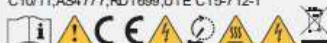
SOFAR SOLAR	
PV Grid Inverter	SOFAR 1100TL
Maximum DC input voltage	450V
DC voltage range	90-400V
Maximum DC input current	10A
Maximum PV Isc	12A
Nominal Grid voltage	L/N/PE 230V~
Maximum AC output current	4.5A
Nominal Grid frequency	50Hz
Maximum AC output power	1000W
Power factor	1
Ingress protection	IP65
Operating temperature range	-25-+60°C
Protective class	Class I
Manufacturer: Shenzhen SOFARSOLAR Co., Ltd. Made in China	
VDE0126-1-1,VDE-AR-N 4105,G83/2,EN50438, C10/11,AS4777,RD1699,UTE C15-712-1	
	

SOFAR SOLAR	
PV Grid Inverter	SOFAR 1600TL
Maximum DC input voltage	450V
DC voltage range	90-400V
Maximum DC input current	10A
Maximum PV Isc	12A
Nominal Grid voltage	L/N/PE 230V~
Maximum AC output current	7A
Nominal Grid frequency	50Hz
Maximum AC output power	1500W
Power factor	1
Ingress protection	IP65
Operating temperature range	-25-+60°C
Protective class	Class I
Manufacturer: Shenzhen SOFARSOLAR Co., Ltd. Made in China	
VDE0126-1-1,VDE-AR-N 4105,G83/2,EN50438, C10/11,AS4777,RD1699,UTE C15-712-1	
	

SOFAR SOLAR	
PV Grid Inverter	SOFAR 2200TL
Maximum DC input voltage	500V
DC voltage range	100-480V
Maximum DC input current	13A
Maximum PV Isc	15A
Nominal Grid voltage	L/N/PE 230V~
Maximum AC output current	9.5A
Nominal Grid frequency	50Hz
Maximum AC output power	2000W
Power factor	1
Ingress protection	IP65
Operating temperature range	-25-+60°C
Protective class	Class I
Manufacturer: Shenzhen SOFARSOLAR Co., Ltd. Made in China	
VDE0126-1-1,VDE-AR-N 4105,G83/2,EN50438, C10/11,AS4777,RD1699,UTE C15-712-1	
	

SOFAR SOLAR	
PV Grid Inverter	SOFAR 2700TL
Maximum DC input voltage	500V
DC voltage range	100-480V
Maximum DC input current	13A
Maximum PV Isc	15A
Nominal Grid voltage	L/N/PE 230V~
Maximum AC output current	11.5A
Nominal Grid frequency	50Hz
Maximum AC output power	2500W
Power factor	1
Ingress protection	IP65
Operating temperature range	-25-+60°C
Protective class	Class I
Manufacturer: Shenzhen SOFARSOLAR Co., Ltd. Made in China	
VDE0126-1-1,VDE-AR-N 4105,G83/2,EN50438, C10/11,AS4777,RD1699,UTE C15-712-1	
	

SOFAR SOLAR	
PV Grid Inverter	SOFAR 3000TL
Maximum DC input voltage	500V
DC voltage range	100-480V
Maximum DC input current	13A
Maximum PV Isc	15A
Nominal Grid voltage	L/N/PE 230V~
Maximum AC output current	13A
Nominal Grid frequency	50Hz
Maximum AC output power	2800W
Power factor	1
Ingress protection	IP65
Operating temperature range	-25-+60°C
Protective class	Class I
Manufacturer: Shenzhen SOFARSOLAR Co., Ltd. Made in China	
VDE0126-1-1,VDE-AR-N 4105,G83/2,EN50438, C10/11,AS4777,RD1699,UTE C15-712-1	
	

DRM0	<input checked="" type="checkbox"/>	DRM1	<input type="checkbox"/>	DRM2	<input type="checkbox"/>
DRM3	<input type="checkbox"/>	DRM4	<input type="checkbox"/>	DRM5	<input type="checkbox"/>
DRM6	<input type="checkbox"/>	DRM7	<input type="checkbox"/>	DRM8	<input type="checkbox"/>

General product information:

The Solar Inverter converts DC voltage into AC voltage.

The input and output are protected by varistors to Earth. The unit is providing EMC filtering at the PV input and output toward mains. The unit does not provide galvanic separation from input to output (transformerless). The output is switched off redundantly by the high power switching bridge and two relays. This assures that the opening of the output circuit will also operate in case of a single error.

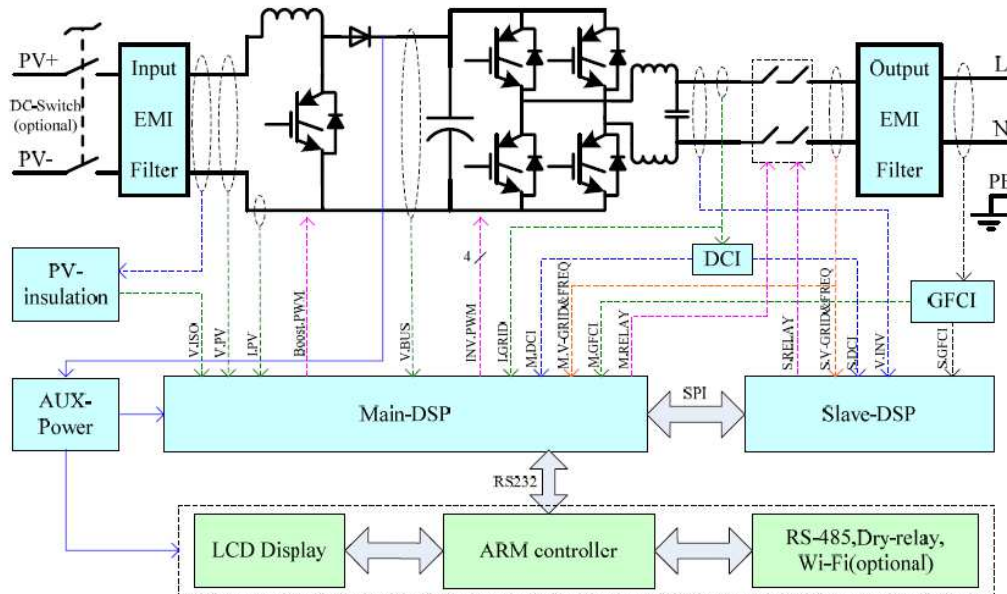

Figure 1 Block diagram

The internal control is redundant built. It consists of Microcontroller Master DSP (UC34) and Slave DSP (UC35).

The Master DSP control the relays (RYP2-RYP5) by switching signals; measures the PV voltage, PV current, Bus voltage, grid voltage, frequency, AC current with injected DC and the array insulation resistance to ground. In addition it tests the current sensors and the RCMU circuit before each start up.

The Slave DSP (UC35) is measures the grid voltage, AC current, grid frequency and residual current, also can switch off the relays (RYP2-RYP5) independently, and communicate with Master DSP (UC34) each other.

The current is measured by a current sensor. The AC current signal and the injected DC current signal are sent to the Master DSP(UC34). The Master DSP(UC34) tests and calibrates before each start up all current sensors.

The unit provides two relays in series in all output conductors. When single fault applied to one relay, alarm an error code in display panel, another redundant relay provides basic insulation maintained between the PV array and the mains. All the relays are tested before each start up.

The product was tested on:
Hardware version: V1.00
Software version: V3.20

Description of the differences of the models within a series:

The models SOFAR 1100TL, SOFAR 1600TL, SOFAR 2200TL, SOFAR 2700TL and SOFAR 3000TL are same as in hardware except the components are in the difference table. Identical in software the output power just adjusted by software.

Difference table					
	SOFAR 1100TL	SOFAR 1600TL	SOFAR 2500TL	SOFAR 2700TL	SOFAR 3000TL
Boost inductor	2,6mH	2,6mH	1,9mH	1,9mH	1,9mH
Resistor (RP105, RP108 /RP189,RP109)	220ohm / 10Kohm	220ohm / 10Kohm	200ohm / 7,5Kohm	200ohm / 7,5Kohm	200ohm / 7,5Kohm
BUS capacitor (ECP1, ECP3, ECP4)	2 pcs	2 pcs	3 pcs	3 pcs	3 pcs
Inverter inductor	3,4mH	2,3mH	2,1mH	1,5mH	1,3mH
Resistor (RP118, RP119, RC18 /RP120, RP121,RC22)	499 Ω, 200 Ω, 200 Ω	1 KΩ, 200 Ω, 100 Ω	1 KΩ, 330 Ω, 330 Ω	2 KΩ, 100 Ω, 100 Ω	2 KΩ, 100 Ω, 100 Ω
DC switch and Wi-Fi module are optional.					

AS/NZS 4777.2 – 2015			
Clause	Requirement – Test	Result - Remark	Verdict
5	GENERAL REQUIREMENTS		P
5.1	Electrical safety		P
	Inverters for use in inverter energy systems with photovoltaic (PV) arrays shall comply with the appropriate electrical safety requirements of IEC 62109-1 and IEC 62109-2, and the requirements within this Standard.	An applicable test report according to IEC 62109-1, IEC 62109-2 must be provided by the manufacturer.	P
	Inverters for use in inverter energy systems that have energy storage (batteries) as the only possible energy source shall comply with the electrical safety requirements of AS 62040.1.1, and the requirements within this Standard.	No such the energy storage system.	N/A
	Inverters for use in inverter energy systems that incorporate energy sources other than photovoltaic (PV) arrays or batteries shall comply with the applicable electrical safety requirements of IEC 62109-1 and IEC 62109-2, and the requirements within this Standard.	An applicable test report according to IEC 62109-1, IEC 62109-2 must be provided by the manufacturer.	P
5.2	Provision for external connections	Provided in the installation manual.	P
	Inverters shall be used and installed as fixed equipment only.		P
	Inverter provisions for external connection	See below.	P
	(a) shall be for fixed equipment only; and	Complied.	P
	(b) shall provide for safe and reliable connection to any d.c. source or load or any a.c. source or load.	Provided in the installation manual.	P
	All inverter ports (except communications ports) shall incorporate connection types for either -	See below.	P
	(i) permanently connected equipment; or	pluggable type B equipment	N/A
	(ii) pluggable type B equipment.		P
	Inverter source or load connections shall not incorporate connection types for pluggable type A equipment.		P
	Permanently connected inverters shall have suitable terminals for connection to fixed installation wiring.	pluggable type B equipment	N/A
	Pluggable type B equipment shall have one of the following means of connection:	See below.	P
	(A) A non-detachable cord for connection to the supply by means of a connector.		N/A
	(B) An appliance inlet suitable for		P

	connection to a matching connector.		
	Pluggable type B equipment shall not incorporate -	See below.	P
	(1) a connection by a connector or inlet complying with any of the dimensional sheets of AS/NZS 60320.1;		N/A
	(2) a connection by a plug conforming to AS/NZS 3112; or	No such plug used.	P
	(3) a connection by a connector or inlet where hazardous voltages are accessible by the standard test finger.	No such devices.	P
5.3	Photovoltaic (PV) array earth fault/earth leakage detection		P
	For inverter energy systems used with PV array systems that require earth fault detection and a residual current detection, either internal or external to the inverter, the type of detection used shall be declared in accordance with IEC 62109-1 and IEC 62109-2.	An applicable test report according to IEC 62109-1, IEC 62109-2 must be provided by the manufacturer.	P
	If an external residual current device (RCD) is required, the manufacturer's installation instructions shall state the need for an RCD and shall specify its rating, type and required circuit location in accordance with Clause 9.		N/A
	Where the additional detection for functionally earthed PV arrays, as required by AS/NZS 5033, is present in the inverter, this additional detection shall, before start-up of the system -	See below.	P
	(a) open circuit the functional earth connection to the PV array;		P
	(b) measure the resistance to earth of each conductor of the PV array;	An applicable test report according to IEC 62109-1, IEC 62109-2 must be provided by the manufacturer.	P
	(c) if the earth resistance is above the resistance limit (Riso limit) threshold specified in Table 1, the system shall reconnect the functional earth and shall be allowed to start; and	An applicable test report according to IEC 62109-1, IEC 62109-2 must be provided by the manufacturer.	P
	(d) if the earth resistance is equal to or less than the resistance limit (Riso limit) threshold specified in Table 1, the inverter shall shut down and initiate an earth fault alarm in accordance with the requirements of IEC 62109-2.	An applicable test report according to IEC 62109-1, IEC 62109-2 must be provided by the manufacturer.	P
5.4	Compatibility with electrical installation		P
	The inverter shall be compatible with wiring practices for LV electrical installations of AS/NZS 3000 and	Considered.	P

	variations as required in AS/NZS 4777.1. The inverter a.c. voltage and frequency operation shall comply with the limits specified in AS 60038 (for Australia), or IEC 60038 (for New Zealand).		
5.5	Power factor	See below.	P
	The displacement power factor of the inverter, considered as a load from the perspective of the grid, shall, for all current outputs from 25% to 100% of rated current, operate at unity power factor within the range 0.95 leading to 0.95 lagging.	See appendix table 5.5 Power factor.	P
	Operation at power factor other than unity is acceptable where the inverter operates in power quality response modes.	See Clause 6.3.	P
5.6	Harmonic currents	See below.	P
	The harmonic currents of the inverter shall not exceed the limits specified in Tables 2 and 3 and the total harmonic current distortion (ITHD) to the 50th harmonic shall be less than 5%.	See appendix table 5.6 Harmonic currents.	P
5.7	Voltage fluctuations and flicker	See below.	P
	The inverter shall conform to the voltage fluctuation and flicker limits specified in AS/NZS 61000.3.3 for equipment with rated current less than or equal to 16 A per phase (a.c.).	See appendix table 5.7 Voltage Fluctuations and Flicker.	P
	For equipment with rated current greater than 16 A per phase (a.c.), The impedance shall be determined in accordance with the methods given in AS/NZS 61000.3.11.	See appendix table 5.7 Voltage Fluctuations and Flicker.	N/A
5.8	Transient voltage limits	See below.	P
	To prevent damage to electrical equipment connected to the same circuit as the inverter, disconnection of the inverter from the grid shall not result in transient overvoltages beyond the limits specified in Table 4.	See appendix table 5.8 Transient Voltage Limits (phase to neutral).	P
5.9	D.C. current injection	See below.	P
	In the case of a single-phase inverter, the d.c. output current of the inverter at any a.c. port including the grid-interactive and/or stand-alone port shall not exceed 0.5% of the inverter's rated current or 5 mA, whichever is the greater.	See appendix table 5.9 Direct current injection.	P
	In the case of a three-phase inverter, the d.c. output current of the inverter at any a.c. port, including the grid-interactive	The inverter is single-phase type.	N/A

	and/or stand-alone port, measured in each of the phases, shall not exceed 0.5% of the inverter's per-phase rated current or 5 mA, whichever is the greater.		
5.10	Current balance for three-phase inverters	The inverter is single-phase type.	N/A
	In the case of a three-phase inverter the a.c. output current shall be generated and injected into the three-phase electrical installation as a three-phase balanced current.		N/A

6	OPERATIONAL MODES AND MULTIPLE MODE INVERTERS		P
6.1	General		P
	Unless otherwise stated, the modes in the following Clauses are for the grid-interactive port of the inverter.		P
6.2	Inverter demand response modes (DRMs)		P
6.2.1	General	See below.	P
	The inverter shall support the demand response mode DRM 0 of Table 5. The inverter should support the other demand response modes of Table 5.	See appendix table 6.2.	P
	The inverter shall detect and initiate a response to all supported demand response commands within 2 s. The inverter shall continue to respond while the mode remains asserted.	See appendix table 6.2.	P
6.2.2	Interaction with demand response enabling device (DRED)	See below.	P
	The inverter shall have a means of connecting to a DRED. This means of connection shall include a terminal block or RJ45 socket.	Considered.	P
	The terminal block or RJ45 socket shall comply with the minimum electrical specifications in Table 6.	Considered.	P
	The DRED asserts demand response modes by shorting together terminals or pins as specified in Table 7.	Considered.	P
6.3	Inverter power quality response modes		P
6.3.1	General	See below.	P
	The inverter may have the capability of operating in modes which will -		P
	(a) contribute to maintaining the power quality at the point of connection with the customer installation; or		P
	(b) provide characteristics which are outside the typical operation of an inverter		P

	for the purpose of providing support to a grid.		
6.3.2	Volt response modes		P
6.3.2.1	General	See below.	P
	The intent of including the volt response modes, which respond to voltage changes at the inverter terminals, is to increase the number of systems which can be connected at a point on the grid without adversely affecting the voltage within an electrical installation.		P
	The volt-watt and volt-var response modes specified in Clause 6.3.2.2 and Clause 6.3.2.3 shall use the volt response reference values specified in Table 9.		P
6.3.2.2	Volt-watt response mode	See below.	P
	The inverter should have the volt-watt response mode. If this mode is available, it shall be enabled by default.		P
	The response curve required for the volt-watt response mode is defined by the volt response reference values in Table 9 and corresponding power levels. The default values are listed in Table 10 and example response modes are shown in Figure 2(A) for Australia and Figure 2(B) for New Zealand.	See appendix table 6.3.2.2.	P
6.3.2.3	Volt-var response mode		N/A
	The inverter should have the volt-var response capability. If this mode is available, it shall be disabled by default.		N/A
	The response curve required for the volt-var response is defined by the volt response reference values specified in Table 9 and corresponding var levels. The default values are listed in Table 11 and shown in Figure 3.		N/A
6.3.2.4	Voltage balance modes		N/A
	Three-phase inverters, or single-phase inverters used in a three-phase combination may be used for voltage balancing between phases by injecting unbalanced three-phase currents into the electrical installation.	The EUT is single-phase type, and it's not used in a three-phase combination.	N/A
	If the voltage balance mode is available, the following requirements apply:		N/A
	(a) The voltage balance mode shall be disabled by default.		N/A
	(b) For single-phase inverters used in a three-phase combination, the		N/A

	requirements of Clause 8.2 apply.		
	(c) The voltage balancing mode shall be able to -		N/A
	(i) operate correctly with a single fault applied;		N/A
	(ii) detect the fault or loss of operability and cause the inverter to revert to injecting current into the three-phase electrical installation as a three-phase balanced current; or		N/A
	(iii) detect the fault or loss of operability and disconnect the inverter from the electrical installation.		N/A
6.3.3	Fixed power factor mode and reactive power mode		N/A
	These modes shall be disabled by default.		N/A
	If the inverter is capable of operating with reactive power mode, the maximum ratio of reactive power (vars) to rated apparent power should be 100%.		N/A
	If the inverter is capable of operating with fixed power factor mode, the minimum range of settings should be 0.8 leading to 0.8 lagging.		N/A
6.3.4	Characteristic power factor curve for $\cos \varphi$ (P) (Power response)		N/A
	If this mode is available, it shall be disabled by default.		N/A
	The response curve required for the $\cos \varphi$ (P) response should be defined within displacement power factor range of 0.9 leading to 0.9 lagging. One possible $\cos \varphi$ (P) curve is shown in Figure 4.		N/A
6.3.5	Power rate limit		P
6.3.5.1	General	See below.	P
	The power rate limit for an inverter is a power quality response mode.		P
	The inverter shall have the capability to rate limit changes in power generation through the grid-interactive port.		P
	Inverters capable of multiple mode operation should have the capability to rate limit changes in power consumption (for example increasing/decreasing of charging rates of connected energy storage).		N/A
	The power rate limit does not apply when the inverter disconnection device is required to operate (i.e. to disconnect).		P

6.3.5.2	Gradient of power rate limit		P
	The default setting for the power rate limit (WGr _a) for increase and decrease shall be 16.67% of rated power per minute which is a nominal ramp time of 6 min.	See appendix table 6.3.5.	P
	The power rate limit (WGr _a) shall be adjustable within the range 5% to 100% of rated power per minute.	See appendix table 6.3.5.	P
	It is acceptable to have two separate power rate limits for increase and decrease in output power, as follows:		N/A
	(a) To rate limit an increase in power (WGr _{a+}).	Considered.	P
	(b) To rate limit a decrease in power (WGr _{a-}).		N/A
6.3.5.3	Power rate limit modes		P
6.3.5.3.1	General		P
	The inverter power rate limit (WGr _a) is applicable to operate in the following modes:		P
6.3.5.3.2	Soft ramp up after connect or reconnect		P
	All inverters shall have this mode. This mode shall be enabled as per Clause 7.7 and for the increase in power required by Clause 7.5.3 after frequency decreased to the required limit.	See appendix table.	P
6.3.5.3.3	Changes in a.c. operation and control	No such function.	N/A
	If available, this mode shall be enabled for a change in a demand response mode of Clause 6.2 (except for DRM 0).		N/A
	The power rate limit for changes in a.c. operation and control does not apply to those inverters that are correcting for sags and swells of less than 1 min.		N/A
6.3.5.3.4	Changes in energy source operation	No energy source in the EUT.	N/A
	This mode only applies to multiple mode inverters with energy storage. It operates when there is a change in the energy resource available to the inverter, which causes a change in output through the grid-interactive port.		N/A
	For this mode the power rate limit (WGr _a) should apply to the increase or decrease in power generation or consumption, and to the transitions between power output levels.		N/A
	For this mode, the power rate limit (WGr _a) should be able to be enabled or disabled.		N/A

	The power rate limit shall be disabled by default.		N/A
	The increase or decrease for transitions between power output levels is contingent on external situations (such as amount of available solar energy, wind energy or discharge capacity).		N/A
	Only for increases or decreases in the output which are faster than the power rate limit (WGra) does a control action to limit the ramp rate apply.		N/A
6.3.5.4	Nonlinearity of power rate limit changes		P
	The nonlinearity (NL) of the power rate limit (WGra) in response to an increase of the inverter power output, as defined by the characteristic curve depicted in Figure 5, shall be less than 10%.		P
6.4	Multiple mode inverter operation	No multiple mode.	N/A
6.4.1	General		N/A
	When the multiple mode inverter is disconnected from the grid any stand-alone port shall ensure that all active conductors are also isolated from the grid-interactive port.		N/A
	Multiple mode inverters shall be arranged to ensure that the continuity of the neutral conductor to the load from the electrical installation is not interrupted when the inverter disconnects from the grid and supplies a load via the stand-alone port.		N/A
	When the multiple mode inverter is providing the stand-alone function and is disconnected from the grid, the stand-alone port shall comply with the requirements for d.c. current injection (refer to Clause 5.9) into the connected load circuits. The type of RCD compatible with and for use on the stand-alone function outputs shall be declared.		N/A
6.4.2	Sinusoidal output in stand-alone mode	The EUT is grid-tied type.	N/A
	The a.c. output voltage waveform of a stand-alone port of a multiple mode inverter operating in stand-alone mode, shall comply with the requirements of this Clause (6.4.2). The a.c. output voltage waveform of a stand-alone mode shall have a voltage total harmonic distortion (THD) not exceeding of 5% and no individual harmonic at a level exceeding 5%.		N/A
6.4.3	Volt-watt response mode for charging of energy storage	No energy storage system in the EUT.	N/A

	A multiple mode inverter with energy storage which can be charged from the grid shall have this volt-watt response mode.		N/A
	This volt-watt response mode is only active when power from the grid is required to charge the energy storage.		N/A
	The response curve required for the volt-watt response is defined by the volt response reference values in Table 9 and corresponding power consumption from the grid through the grid-interactive port for charging energy storage. The default values are listed in Table 12 and shown in Figure 6.		N/A
6.5	Security of operational settings		P
	The internal settings of the demand response or power quality response modes of the inverter shall be secured against inadvertent or unauthorized tampering.	Considered.	P
	Changes to the internal settings shall require the use of a tool and special instructions not provided to unauthorized personnel.	Provide in installation manual.	P

7	PROTECTIVE FUNCTIONS FOR CONNECTION TO ELECTRICAL INSTALLATIONS AND THE GRID		P
7.1	General	See below.	P
	The automatic disconnection device shall operate -	The automatic disconnection device is integral part of the inverter.	P
	(a) if supply from the grid is disrupted;	Considered.	P
	(b) when the grid goes outside preset parameters (e.g. undervoltage/overvoltage, under-frequency/over-frequency); or	Considered.	P
	(c) when the demand response mode DRM 0 (see Clause 6.2) is asserted.	Considered.	P
	For inverter energy systems connected to multiple phases the automatic disconnection device shall operate if any of the above conditions is met on any phase.	Considered.	P
7.2	Automatic disconnection device		P
	The automatic disconnection device shall provide isolation in all live conductors	The unit provides galvanic separation. The unit is switched off redundant by the high power bridge of the inverter and the relays in line and neutral.	P

	The automatic disconnection device shall be capable of interrupting at least the rated current.	Considered.	P
	The settings of the automatic disconnection device shall not exceed the capability of the inverter.	Considered.	P
	A semiconductor (solid-state) device shall not be used for isolation purposes.	Considered.	P
7.3	Active anti-islanding protection	See below.	P
	The automatic disconnection device shall incorporate at least one method of active anti-islanding protection.	Considered.	P
	The method used to provide active anti-islanding protection shall be declared.	Rate of change of frequency (RoCof) detection method used.	P
	To prevent islanding, the active anti-islanding protection system shall operate the automatic disconnection device (see Clause 7.2) within 2 s of disruption to the power supply from the grid.	See appendix table 7.3.	P
	Compliance shall be determined by type testing in accordance with the active anti-islanding tests specified in Appendix F or IEC 62116.	Considered.	P
7.4	Voltage and frequency limits (passive anti-islanding protection)		P
	The automatic disconnection device shall incorporate the following forms of passive anti-islanding protection:	Considered.	P
	(a) Undervoltage and overvoltage protection.	See appendix table7.4.	P
	(b) Under-frequency and over-frequency protection.	See appendix table7.4.	P
7.5	Limits for sustained operation		P
7.5.1	General	See below.	P
	The inverter or inverter energy system shall remain connected over the range of voltages and frequencies that it is required to be compatible with. Refer to Clause 5.4.	Considered.	P
7.5.2	Sustained operation for voltage variations	See below	P
	The inverter shall operate the automatic disconnection device (see Clause 7.2) within 3 s when the average voltage for a 10 min period exceeds the V_{nom_max} , where V_{nom_max} lies in the range 244–258 V.	See appendix table7.5.2.	P
	The default set-point for V_{nom_max} shall be as follows:	See appendix table7.5.2.	P

	(a) In Australia: 255 V. (b) In New Zealand: 248 V.		
7.5.3	Sustained operation for frequency variations		P
7.5.3.1	Response to an increase in frequency		P
	The inverter shall be capable of supplying rated power between 47 Hz and 50.25 Hz for Australia.	Considered.	P
	The inverter shall be capable of supplying rated power between 45 Hz and 50.25 Hz for New Zealand.		N/A
	The power level present at the time the frequency reaches or exceeds 50.25 Hz shall be held as the reference power level used to calculate the required response to the increasing frequency.	Considered.	P
	This is expressed in the equation below: $P_{out} = P_{ref} \left[1 - \frac{(f - 50.25)}{(f_{stop} - 50.25)} \right]$ where P_{out} = required output for a frequency between 50.25 Hz and f_{stop} P_{ref} = reference power level when the frequency reaches or exceeds 50.25 Hz f = frequency between 50.25 Hz and f_{stop} When the frequency exceeds f_{stop} the inverter power output shall be ceased (i.e. 0 W). The default set-point for f_{stop} shall be 52 Hz.	See appendix table 7.5.3.1.	P
	Unconstrained power operation may recommence 6 min after the frequency returns to and remains at less than 50.15 Hz.	See appendix table 7.5.3.1.	P
7.5.3.2	Response to a decrease in grid frequency		N/A
	This requirement applies only to inverters with energy storage.	The EUT without energy storage.	N/A
	The inverter shall be capable of charging the energy storage between 49.75 Hz and 52.0 Hz.		N/A
	The power input level for charging present at the time the frequency reaches or falls below 49.75 Hz shall be held as the reference charge rate used to calculate the required response to the decreasing frequency.		N/A
	This is expressed in the equation below:		N/A

	$P_{\text{charge}} = P_{\text{ref}} \left[1 - \frac{(49.75 - f)}{(49.75 - f_{\text{stop-CH}})} \right]$ <p>where P_{charge} = charge rate of the storage element for a frequency between 49.75 Hz and $f_{\text{stop-CH}}$ $P_{\text{ref-CH}}$ = charge rate of the storage element when the frequency reaches or falls below 49.75 Hz f = frequency between 49.75 Hz and $f_{\text{stop-CH}}$</p> <p>When the frequency falls below $f_{\text{stop-CH}}$, the inverter should have ceased charging the storage element (i.e. 0 W). The default set-point for $f_{\text{stop-CH}}$ should be 49 Hz.</p>		
	Unconstrained charging of the storage element may recommence 6 min after the frequency returns to and remains above than 49.85 Hz.		N/A
7.6	Disconnection on external signal	See below	P
	The automatic disconnection device shall incorporate the ability to disconnect on an external signal.	The automatic disconnection device is integral part of the inverter.	P
	If an external signal or demand response 'DRM 0' condition is asserted, the automatic disconnection device shall operate within 2 s.	Considered.	P
7.7	Connection and reconnection procedure	See below	P
	Only after all of the following conditions have been met shall the automatic disconnection device operate to connect or reconnect the inverter to the grid -	The unit provides monitoring of the voltage, frequency and synchronisation. If one of these conditions is not met, then the unit is not switching on.	P
	(a) the voltage of the grid has been maintained within the limits of AS 60038 (for Australia) or IEC 60038 (for New Zealand) for at least 60 s;	Considered	P
	(b) the frequency of the grid has been maintained within the range 47.5 Hz to 50.15 Hz for at least 60 s;	Considered	P
	(c) the inverter and the grid are synchronized and in-phase with each other; and	Considered	P
	(d) no external signal is present or DRM 0 asserted requiring the system to be disconnected.	Considered	P
7.8	Security of protection settings		P
	The internal settings of the automatic	Changes to the internal settings	P

	disconnection device shall be secured against inadvertent or unauthorized tampering. Changes to the internal settings shall require the use of a tool and special instructions not provided to unauthorized personnel.	shall require the use of a tool and special instructions provided to authorized personnel.	
--	--	--	--

8	MULTIPLE INVERTER COMBINATIONS		N/A
8.1	General	See below.	N/A
	If a combination is not tested, it should not be used or external devices should be used in accordance with the requirements of AS/NZS 4777.1.	The inverter is single phase type, and it should not be used in parallel and multiple phase installations.	N/A
	Possible combinations are single-phase inverters used in parallel, single-phase inverters used in multiple phase installations and three-phase inverters used in parallel.	The inverter is single phase type, and it should not be used in parallel and multiple phase installations.	N/A
8.2	Inverter current balance across multiple phases	The inverter is single phase type, and it should not be used in parallel and multiple phase installations.	N/A
	The maximum current imbalance in a three-phase inverter system comprised of individual single-phase inverters shall be no more than 21.7 A.		N/A
8.3	Grid disconnection	The inverter is single phase type, and it should not be used in parallel and multiple phase installations.	N/A
	When any inverter within the inverter energy system disconnects as required by Clause 7, all inverters within the inverter energy system shall disconnect within 2 s of the first inverter disconnecting.		N/A
	This applies to all inverters used in combination for single-phase or multiple phases.		N/A
8.4	Grid connection and reconnection	The inverter is single phase type, and it should not be used in parallel and multiple phase installations.	N/A
	When multiple inverters are used together in a multiple phase combination, only after all the conditions of Clause 7.7 have been met on all connected phases shall the automatic disconnection device operate to connect or reconnect any inverter of the multiple phase combination to the grid.		N/A
	Where any inverter used in a multiple phase combination has a rated current exceeding 21.7 A per phase, the requirement of Clause 8.2 shall be met when connecting or reconnecting.		N/A

8.5	Testing combinations	The inverter is single phase type, and it should not be used in parallel and multiple phase installations.	N/A
8.5.1	Single-phase combinations	The inverter is single phase type, and it should not be used in parallel and multiple phase installations.	N/A
	Single-phase parallel combinations of inverters shall be tested for combinations with total rated current (I_{rated}) equal to or up to the maximum of 6 A per phase.		N/A
	To determine the number of inverters to be tested, the following equation shall be used: $N = \frac{6}{I_{rated}}$ <p>where N = number to be tested, rounded up to next whole number I_{rated} = rating of the inverter in amperes</p> <p>If $N \geq 2$, the minimum number of inverters to be tested shall be N. If $N > 6$, the maximum number of inverters to be tested in a combination shall be 6.</p>		N/A
8.5.2	Single-phase inverters used in three-phase combinations	The inverter is single phase type, and it should not be used in parallel and multiple phase installations.	N/A
	For single-phase inverters with rated current (I_{rated}) greater than or equal to 5 A used in three-phase combinations, three inverters shall be tested in a three-phase arrangement [refer to Figure 8(a)].		N/A
	Single-phase inverters with rated current less than 5 A and to be used in three-phase combinations shall be tested in combination with at least two inverters per phase [refer to Figure 8(b)].		N/A
8.5.3	Required tests for multiple inverter combinations	The inverter is single phase type, and it should not be used in parallel and multiple phase installations.	N/A
	Any single-phase inverter used in a multiple inverter combination shall be tested individually and meet all the requirements of this Standard. Any single-phase inverter which is to be used as part of a multiple inverter combination shall be tested in combination as specified in Clauses 8.5.1 and 8.5.2.		N/A
8.5.4	Multiple inverters with one automatic disconnection device	The inverter is single phase type, and it should not be used in parallel	N/A

		and multiple phase installations.	
	Where the inverter does not have an internal automatic disconnection device, or requires an external automatic disconnection device to provide the required disconnection function, or both, testing shall be conducted with the automatic disconnection device and with either the number of inverters required by Clause 8.5.1 and 8.5.2 or with the automatic disconnection device configured with the number of inverters specified by the manufacturer's instructions.		N/A

9	INVERTER MARKING AND DOCUMENTATION		P
9.1	General		P
	All markings and documentation shall be in the English language.		P
9.2	Marking		P
9.2.1	General		P
9.2.2	Equipment ratings	See below	P
	Photovoltaic		-
	Vmax PV (absolute maximum)	450Vdc for SOFAR 1100TL, SOFAR 1600TL; 500Vdc for SOFAR 2200TL, SOFAR 2700TL, SOFAR 3000TL	P
	Isc PV (absolute maximum)	12,0A for SOFAR 1100TL, SOFAR 1600TL; 15,0A for SOFAR 2200TL, SOFAR 2700TL, SOFAR 3000TL	P
	Wind (a.c. or d.c.)		-
	Voltage (nominal or range)		N/A
	Rated current (maximum continuous)		N/A
	Frequency (nominal or range) (a.c. wind only)		N/A
	Energy storage ports		-
	Voltage (nominal)		N/A
	Voltage (range)		N/A
	Rated current (maximum continuous)		N/A
	Storage type		N/A
	Other energy sources or inputs (a.c. or d.c.)		-
	Voltage (nominal or range)		N/A

	Rated current (maximum continuous)		N/A
	Power factor (range)		N/A
	Frequency (nominal or range) (a.c. sources only)		N/A
	a.c. output ratings (for each port)		-
	Voltage (nominal or range)	230Vac	P
	Rated current	4,5A for SOFAR 1100TL; 7,0A for SOFAR 1600TL; 9,5A for SOFAR 2200TL; 11,5A for SOFAR 2700TL; 13,0A for SOFAR 3000TL;	P
	Frequency (nominal or range)	50Hz	P
	Rated apparent power	1000VA for SOFAR 1100TL; 1500VA for SOFAR 1600TL; 2000VA for SOFAR 2200TL; 2500VA for SOFAR 2700TL; 2800VA for SOFAR 3000TL;	P
	Power factor range	1,0	P
	d.c. output ratings		-
	Voltage (nominal or range)		N/A
	Rated current		N/A
	Inverter topology	Non-isolated.	P
	Protective class (I, II or III)	Class I	P
	Ingress protection (IP) rating	IP65	P
9.2.3	Ports		P
	Each port shall be marked with its classification and indicate whether a.c or d.c. voltage as appropriate.	The classification marking were provided adjacent to the terminals of each port.	P
9.2.4	External and ancillary equipment	Ref to installation manual.	P
9.2.5	Residual current devices (RCDs)		N/A
	Where an external RCD is required, the inverter shall be marked with a warning along with the rating and type of RCD required. The warning shall be located in a prominent position and written in lettering at least 5 mm high. It shall contain the following or an equivalent statement: WARNING: AN RCD IS REQUIRED ON THE [NAME] PORTS OF THE INVERTER	The Residual current devices (RCDs) is integral part of inverter. An applicable test report according to IEC 62109-1, IEC 62109-2 must be provided by the manufacturer.	N/A
	If the inverter energy system requires a Type B RCD, the inverter shall be marked with a warning. The warning shall be	The Residual current devices (RCDs) is integral part of inverter. An applicable test report according	N/A

	located in a prominent position and written in lettering at least 5 mm high. It shall contain the following: WARNING: A TYPE B RCD IS REQUIRED ON THE [NAME] PORTS OF THE INVERTER	to IEC 62109-1, IEC 62109-2 must be provided by the manufacturer.	
9.2.6	Demand response modes		P
	The demand response modes supported by the inverter should be permanently marked on the name plate or on a durable sticker located on or near the demand response interface port to indicate the demand response modes of which the unit is capable.	The demand response modes supported by the inverter has permanently marked on the name plate closed the communication terminals for DRED.	P
9.3	Documentation		P
9.3.1	General		P
9.3.2	Equipment ratings	See below	P
	Photovoltaic		-
	Vmax PV (absolute maximum)	450Vdc for SOFAR 1100TL,SOFAR 1600TL; 500Vdc for SOFAR 2200TL,SOFAR 2700TL, SOFAR 3000TL	P
	PV input operating voltage range	90-400Vdc for SOFAR 1100TL,SOFAR 1600TL; 100-480Vdc for SOFAR 2200TL,SOFAR 2700TL, SOFAR 3000TL	P
	Maximum operating PV input current	10,0A for SOFAR 1100TL,SOFAR 1600TL; 13,0A for SOFAR 2200TL,SOFAR 2700TL, SOFAR 3000TL	P
	Isc PV (absolute maximum)	12,0A for SOFAR 1100TL,SOFAR 1600TL; 15,0A for SOFAR 2200TL,SOFAR 2700TL, SOFAR 3000TL	P
	Maximum inverter backfeed current to array	0A	P
	Wind (a.c. or d.c.)		-
	Voltage (nominal or range)		N/A
	Rated current (maximum continuous)		N/A
	Current (inrush)		N/A
	Frequency (nominal or range) (a.c. wind only)		N/A
	Energy storage ports		-
	Voltage (nominal or range)		N/A

	Nominal battery voltage		N/A
	Rated current (maximum continuous) input and output		N/A
	Storage type		N/A
	Other energy sources or inputs (a.c. or d.c.)		-
	Voltage (nominal or range)		N/A
	Rated current (maximum continuous)		N/A
	Power factor (range)		N/A
	Frequency (nominal or range) (a.c. sources only)		N/A
	a.c. output ratings (for each port)		-
	Voltage (nominal or range)	230Vac	P
	Rated current	4,5A for SOFAR 1100TL; 7,0A for SOFAR 1600TL; 9,5A for SOFAR 2200TL; 11,5A for SOFAR 2700TL; 13,0A for SOFAR 3000TL;	P
	Current (inrush)	0,8A/2us	P
	Frequency (nominal or range)	50,0Hz	P
	Rated apparent power	1000VA for SOFAR 1100TL; 1500VA for SOFAR 1600TL; 2000VA for SOFAR 2200TL; 2500VA for SOFAR 2700TL; 2800VA for SOFAR 3000TL;	P
	Power factor range	1,0	P
	Maximum output fault current	200A	P
	Maximum output overcurrent protection	SOFAR 1100TL: 4.5 a.c. A SOFAR 1600TL: 7.0 a.c. A SOFAR 2200TL: 9.5 a.c. A SOFAR 2700TL: 11.5 a.c. A SOFAR 3000TL: 13.0 a.c. A	P
	d.c. output ratings		-
	Voltage (nominal or range)		N/A
	Rated current		N/A
	Inverter topology	Non-isolated.	P
	Active anti-islanding method		P
	Protective class (I, II or III)	Class I	P
	Over voltage category	PV side:OVC II; AC side:OVC III	P
	Ingress protection (IP) rating	IP65	P
	Temperature operating range	-25 ~ +60°C	P

9.3.3	Ports		P
9.3.4	External and ancillary equipment	Provided in installation manual.	P
9.3.5	RCDs		P
9.3.6	Multiple mode inverters	No such mode.	N/A
9.3.7	Multiple inverter combinations	No such combinations.	N/A
APPENDIX A	GENERAL TEST AND REPORTING REQUIREMENTS (Normative)		P
APPENDIX B	POWER FACTOR TEST (Normative)		P
APPENDIX C	HARMONIC CURRENT LIMIT TEST (Normative)		P
APPENDIX D	TRANSIENT VOLTAGE LIMIT TEST (Normative)		P
APPENDIX E	D.C. INJECTION TEST (Normative)		P
APPENDIX F	ACTIVE ANTI-ISLANDING TEST (Normative)		P
APPENDIX G	VOLTAGE AND FREQUENCY LIMITS (PASSIVE ANTI-ISLANDING PROTECTION) TESTS (Normative)		P
APPENDIX H	LIMITS FOR SUSTAINED OPERATION (Normative)		P
APPENDIX I	DEMAND AND POWER QUALITY RESPONSE MODE TESTING INCLUDING DISCONNECTION ON EXTERNAL SIGNAL (Normative)		P
APPENDIX J	MULTIPLE INVERTER TESTING (Normative)		N/A
APPENDIX K	RELATED DOCUMENTS (Informative)		P

Test Results

5.5 Power factor Appendix B Power factor test						P
SOFAR 1100TL						
Mode	Measurement	Rated Output Current				
		15+/-5%	25+/-5%	50+/-5%	75+/-5%	100+/-5%
Unity	Vrms (V)	229,7	229,7	229,8	229,9	229,9
	Arms (A)	0,583	1,022	2,131	3,235	4,338
	Apparent Power (kVA)	0,134	0,235	0,490	0,744	0,997
	Power (kW)	0,134	0,235	0,490	0,744	0,997
	Reactive power (kVar)	0,006	0,003	0,006	0,007	0,011
	PF cos (phi)	0,9991	0,9999	0,9999	1,0000	0,9999
Lag limit	Vrms (V)	-	-	-	-	-
	Arms (A)	-	-	-	-	-
	Apparent Power (kVA)	-	-	-	-	-
	Power (kW)	-	-	-	-	-
	Reactive power (kVar)	-	-	-	-	-
	PF cos (phi)	-	-	-	-	-
Lead limit	Vrms (V)	-	-	-	-	-
	Arms (A)	-	-	-	-	-
	Apparent Power (kVA)	-	-	-	-	-
	Power (kW)	-	-	-	-	-
	Reactive power (kVar)	-	-	-	-	-
	PF cos (phi)	-	-	-	-	-
Modes	Vrms (V)	-	-	-	-	-
	Arms (A)	-	-	-	-	-
	Apparent Power (kVA)	-	-	-	-	-
	Power (kW)	-	-	-	-	-
	Reactive power (kVar)	-	-	-	-	-
	PF cos (phi)	-	-	-	-	-
SOFAR 3000TL						
Mode	Measurement	Rated Output Current				
		15+/-5%	25+/-5%	50+/-5%	75+/-5%	100+/-5%
Unity	Vrms (V)	229,8	229,9	230,1	230,2	230,2
	Arms (A)	1,833	3,106	6,274	9,406	12,509
	Apparent Power (kVA)	0,421	0,714	1,443	2,165	2,880

	Power (kW)	0,421	0,714	1,443	2,165	2,879
	Recative power (kVar)	0,005	0,007	0,018	0,030	0,042
	PF cos (phi)	0,9999	1,0000	0,9999	0,9999	0,9999
Lag limit	Vrms (V)	-	-	-	-	-
	Arms (A)	-	-	-	-	-
	Apparent Power (kVA)	-	-	-	-	-
	Power (kW)	-	-	-	-	-
	Recative power (kVar)	-	-	-	-	-
	PF cos (phi)	-	-	-	-	-
Lead limit	Vrms (V)	-	-	-	-	-
	Arms (A)	-	-	-	-	-
	Apparent Power (kVA)	-	-	-	-	-
	Power (kW)	-	-	-	-	-
	Recative power (kVar)	-	-	-	-	-
	PF cos (phi)	-	-	-	-	-
Modes	Vrms (V)	-	-	-	-	-
	Arms (A)	-	-	-	-	-
	Apparent Power (kVA)	-	-	-	-	-
	Power (kW)	-	-	-	-	-
	Recative power (kVar)	-	-	-	-	-
	PF cos (phi)	-	-	-	-	-

Note:

Inverter shall be connected to test circuit Figure B1 (AS/NZS 4777.2),

The required accuracy for the measurement and reporting of results is ± 0.01 PF. The vars at the 15% test point are required to be the same or less than the vars at the 25% test point when operating at unity power factor.

c: capacitive / leading

i: inductive / lagging

The tests had been performed on the SOFAR 1100TL and SOFAR 3000TL are valid for the SOFAR 1600TL, SOFAR 2200TL, SOFAR 2700TL, since it is identical in hardware and just power derated by software.

5.6 Harmonic currents Appendix C Harmonic Current Limit Test							P
SOFAR 3000TL							
Generating Unit rating per phase (rpp)							
	At 50% of rated output current			100% of rated output currentA			
	Watts	1,451		Watts	2,893		
	VA	1,451		VA	2,894		
	Vrms	230,6		Vrms	230,9		
	Arms	6,293		Arms	12,535		
	PF	1,0000		PF	0,9999		
	Frequency	50,00		Frequency	50,00		
Harmonic	Value A	Angle degrees	% of fundamental	Value A	Angle degrees	% of fundamental	Limit in % of fundamental
0	0,001	-	0,007	0,001	-	0,007	0,5%
1st	6,293	-	48,246	12,534	-	99,994	100%
2nd	0,006	-	0,096	0,005	-	0,043	1%
3rd	0,078	-	1,244	0,125	-	0,996	4%
4th	0,002	-	0,031	0,006	-	0,047	1%
5th	0,021	-	0,328	0,017	-	0,135	4%
6th	0,002	-	0,032	0,002	-	0,015	1%
7th	0,018	-	0,284	0,011	-	0,091	4%
8th	0,003	-	0,047	0,004	-	0,035	1%
9th	0,010	-	0,167	0,004	-	0,032	2%
10th	0,004	-	0,067	0,005	-	0,036	0,5%
11th	0,008	-	0,120	0,012	-	0,097	2%
12th	0,003	-	0,052	0,004	-	0,032	0,5%
13th	0,006	-	0,093	0,005	-	0,043	2%
14th	0,001	-	0,023	0,002	-	0,018	0,5%
15th	0,002	-	0,036	0,012	-	0,098	1%
16th	0,002	-	0,028	0,001	-	0,010	0,5%
17th	0,004	-	0,058	0,012	-	0,098	1%
18th	0,001	-	0,017	0,001	-	0,012	0,5%
19th	0,005	-	0,075	0,009	-	0,071	1%
20th	0,001	-	0,023	0,003	-	0,025	0,5%
21th	0,004	-	0,069	0,012	-	0,099	0,6%
22th	0,001	-	0,024	0,002	-	0,014	0,5%
23th	0,007	-	0,118	0,011	-	0,086	0,6%
24th	0,001	-	0,016	0,001	-	0,009	0,5%
25th	0,007	-	0,118	0,008	-	0,068	0,6%
26th	0,001	-	0,021	0,002	-	0,016	0,5%
27th	0,006	-	0,091	0,009	-	0,075	0,6%
28th	0,001	-	0,023	0,001	-	0,009	0,5%
29th	0,005	-	0,084	0,008	-	0,063	0,6%
30th	0,002	-	0,025	0,001	-	0,012	0,5%
31th	0,006	-	0,088	0,008	-	0,061	0,6%
32th	0,001	-	0,012	0,001	-	0,010	0,5%
33th	0,006	-	0,089	0,007	-	0,055	0,6%
THD (to 50th)	-	-	1,382	-	-	1,054	5%

Note:
Inverter shall be connected to test circuit Figure C1 (AS4777.2), Grid nominal voltage within +/-5%, AC-Frequency 50+/-1Hz and Phase angle between 3 phases shall be 120+/-1.5°. Via DC-input set AC-output power (VA) so that it equals to 100+/-5% of rated output. Harmonic ratios of the test voltage shall be measured. Limits based on percentage of fundamental! Total harmonic distortion to the 50th harmonic 5%.

5.6 Harmonic currents Appendix C Harmonic Current Limit Test							P
Generating Unit rating per phase (rpp)							
	At 50% of rated output current			100% of rated output currentA			
	Watts	0,492		Watts	1,002		
	VA	0,492		VA	1,002		
	Vrms	230,4		Vrms	230,5		
	Arms	2,137		Arms	4,350		
	PF	0,9999		PF	1,0000		
	Frequency	50,00		Frequency	50,00		
SOFAR 1100TL							
Harmonic	Value A	Angle degrees	% of fundamental	Value A	Angle degrees	% of fundamental	Limit in % of fundamental
0	0,001	-	0,021	0,001	-	0,021	0,5%
1st	2,136	-	49,128	4,349	-	100,00	100%
2nd	0,003	-	0,142	0,005	-	0,108	1%
3rd	0,049	-	2,311	0,065	-	1,504	4%
4th	0,002	-	0,072	0,001	-	0,034	1%
5th	0,027	-	1,284	0,027	-	0,613	4%
6th	0,001	-	0,070	0,001	-	0,031	1%
7th	0,022	-	1,036	0,018	-	0,403	4%
8th	0,002	-	0,099	0,003	-	0,070	1%
9th	0,010	-	0,491	0,009	-	0,213	2%
10th	0,003	-	0,120	0,002	-	0,053	0,5%
11th	0,006	-	0,260	0,006	-	0,130	2%
12th	0,003	-	0,130	0,002	-	0,052	0,5%
13th	0,006	-	0,272	0,005	-	0,111	2%
14th	0,003	-	0,121	0,003	-	0,067	0,5%
15th	0,003	-	0,120	0,003	-	0,073	1%
16th	0,002	-	0,100	0,002	-	0,043	0,5%
17th	0,001	-	0,054	0,003	-	0,080	1%
18th	0,001	-	0,063	0,001	-	0,026	0,5%
19th	0,001	-	0,062	0,003	-	0,075	1%
20th	0,001	-	0,051	0,001	-	0,032	0,5%
21th	0,002	-	0,097	0,004	-	0,098	0,6%
22th	0,001	-	0,057	0,001	-	0,021	0,5%
23th	0,001	-	0,049	0,005	-	0,122	0,6%
24th	0,001	-	0,050	0,001	-	0,025	0,5%
25th	0,002	-	0,080	0,005	-	0,111	0,6%
26th	0,001	-	0,052	0,001	-	0,027	0,5%
27th	0,002	-	0,087	0,004	-	0,084	0,6%
28th	0,001	-	0,044	0,001	-	0,024	0,5%
29th	0,002	-	0,087	0,004	-	0,088	0,6%
30th	0,001	-	0,068	0,002	-	0,036	0,5%
31th	0,001	-	0,029	0,002	-	0,055	0,6%
32th	0,001	-	0,047	0,001	-	0,022	0,5%
33th	0,002	-	0,113	0,002	-	0,045	0,6%
THD (to 50th)	-	-	2,951	-	-	1,731	5%

Note:

Inverter shall be connected to test circuit Figure C1 (AS4777.2), Grid nominal voltage within +/-5%, AC-Frequency 50+/-1Hz and Phase angle between 3 phases shall be 120+/-1.5°. Via DC-input set AC-output power (VA) so that it equals to 100+/-5% of rated output. Harmonic ratios of the test voltage shall be measured. Limits based on percentage of fundamental! Total harmonic distortion to the 50th harmonic 5%.

The tests had been performed on the SOFAR 1100TL and SOFAR 3000TL are valid for the SOFAR 1600TL, SOFAR 2200TL, SOFAR 2700TL, since it is identical in hardware and just power derated by software.

5.6 Harmonic currents Appendix C3 Harmonic Voltage Limit Test					P
SOFAR 3000TL					
Generating Unit rating per phase (rpp)					
Harmonic	At 50% of rated output current		100% of rated output current		Limit in % of fundamental
	Value V	% of fundamental	Value V	% of fundamental	
2nd	0,011	0,005	0,011	0,005	0,2%
3rd	0,056	0,024	0,058	0,025	4%
4th	0,007	0,003	0,008	0,003	0,2%
5th	0,051	0,022	0,046	0,020	4%
6th	0,006	0,002	0,005	0,002	0,2%
7th	0,005	0,002	0,006	0,003	4%
8th	0,008	0,004	0,010	0,005	0,2%
9th	0,030	0,013	0,026	0,011	2%
10th	0,003	0,001	0,002	0,001	0,2%
11th	0,012	0,005	0,015	0,006	0,1%
12th	0,008	0,004	0,009	0,004	0,1%
13th	0,018	0,008	0,012	0,005	0,1%
14th	0,003	0,001	0,007	0,003	0,1%
15th	0,011	0,005	0,009	0,004	0,1%
16th	0,007	0,003	0,005	0,002	0,1%
17th	0,005	0,002	0,005	0,002	0,1%
18th	0,005	0,002	0,007	0,003	0,1%
19th	0,012	0,005	0,011	0,005	0,1%
20th	0,002	0,001	0,002	0,001	0,1%
21th	0,007	0,003	0,006	0,003	0,1%
22th	0,005	0,002	0,005	0,002	0,1%
23th	0,008	0,004	0,010	0,004	0,1%
24th	0,002	0,001	0,004	0,002	0,1%
25th	0,016	0,007	0,014	0,006	0,1%
26th	0,003	0,001	0,002	0,001	0,1%
27th	0,011	0,005	0,010	0,004	0,1%
28th	0,003	0,001	0,004	0,002	0,1%
29th	0,007	0,003	0,007	0,003	0,1%
30th	0,002	0,001	0,002	0,001	0,1%
31th	0,009	0,004	0,008	0,003	0,1%
32th	0,002	0,001	0,002	0,001	0,1%
33th	0,009	0,004	0,006	0,003	0,1%
34th	0,002	0,001	0,003	0,001	0,1%
35th	0,008	0,003	0,006	0,002	0,1%

36th	0,002	0,001	0,002	0,001	0,1%
37th	0,008	0,003	0,006	0,003	0,1%
38th	0,002	0,001	0,002	0,001	0,1%
39th	0,008	0,003	0,006	0,002	0,1%
40th	0,002	0,001	0,002	0,001	0,1%
41th	0,007	0,003	0,005	0,002	0,1%
42th	0,002	0,001	0,002	0,001	0,1%
43th	0,007	0,003	0,005	0,002	0,1%
44th	0,002	0,001	0,002	0,001	0,1%
45th	0,007	0,003	0,006	0,002	0,1%
46th	0,002	0,001	0,002	0,001	0,1%
47th	0,006	0,003	0,004	0,002	0,1%
48th	0,002	0,001	0,002	0,001	0,1%
49th	0,006	0,003	0,004	0,002	0,1%
50th	0,002	0,001	0,002	0,001	0,1%
THD		0,041		0,039	5%

Note:

Inverter shall be connected to test circuit Figure C1 (AS4777.2), Grid nominal voltage within +/-5%, AC-Frequency 50+/-1Hz and Phase angle between 3 phases shall be 120+/-1.5°. Via DC-input set AC-output power (VA) so that it equals to 100+/-5% of rated output. Harmonic ratios of the test voltage shall be measured. Limits based on percentage of fundamental! Total harmonic distortion to the 50th harmonic 5%.

5.6 Harmonic currents Appendix C3 Harmonic Voltage Limit Test					P
Generating Unit rating per phase (rpp)					
	At 50% of rated output current		100% of rated output current		
	A		A		
Harmonic	Value V	% of fundamental	Value V	% of fundamental	Limit in % of fundamental
2nd	0,011	0,005	0,011	0,005	0,2%
3rd	0,054	0,024	0,055	0,024	4%
4th	0,007	0,003	0,007	0,003	0,2%
5th	0,056	0,024	0,053	0,023	4%
6th	0,007	0,003	0,006	0,003	0,2%
7th	0,002	0,001	0,003	0,001	4%
8th	0,008	0,003	0,008	0,004	0,2%
9th	0,034	0,015	0,032	0,014	2%
10th	0,004	0,002	0,003	0,002	0,2%
11th	0,007	0,003	0,009	0,004	0,1%
12th	0,008	0,004	0,008	0,004	0,1%
13th	0,021	0,009	0,019	0,008	0,1%
14th	0,002	0,001	0,002	0,001	0,1%
15th	0,009	0,004	0,010	0,004	0,1%
16th	0,008	0,003	0,007	0,003	0,1%
17th	0,009	0,004	0,007	0,003	0,1%
18th	0,004	0,002	0,005	0,002	0,1%
19th	0,011	0,005	0,012	0,005	0,1%
20th	0,004	0,002	0,003	0,001	0,1%
21th	0,008	0,003	0,008	0,004	0,1%
22th	0,006	0,002	0,006	0,002	0,1%
23th	0,006	0,003	0,007	0,003	0,1%
24th	0,002	0,001	0,002	0,001	0,1%

25th	0,014	0,006	0,015	0,006	0,1%
26th	0,004	0,002	0,004	0,002	0,1%
27th	0,012	0,005	0,012	0,005	0,1%
28th	0,003	0,001	0,003	0,001	0,1%
29th	0,006	0,003	0,007	0,003	0,1%
30th	0,003	0,001	0,003	0,001	0,1%
31th	0,007	0,003	0,008	0,003	0,1%
32th	0,002	0,001	0,002	0,001	0,1%
33th	0,007	0,003	0,008	0,003	0,1%
34th	0,002	0,001	0,002	0,001	0,1%
35th	0,007	0,003	0,007	0,003	0,1%
36th	0,003	0,001	0,003	0,001	0,1%
37th	0,006	0,003	0,007	0,003	0,1%
38th	0,002	0,001	0,002	0,001	0,1%
39th	0,007	0,003	0,007	0,003	0,1%
40th	0,002	0,001	0,002	0,001	0,1%
41th	0,006	0,003	0,006	0,003	0,1%
42th	0,002	0,001	0,002	0,001	0,1%
43th	0,007	0,003	0,006	0,003	0,1%
44th	0,002	0,001	0,002	0,001	0,1%
45th	0,007	0,003	0,007	0,003	0,1%
46th	0,002	0,001	0,002	0,001	0,1%
47th	0,006	0,003	0,006	0,002	0,1%
48th	0,002	0,001	0,002	0,001	0,1%
49th	0,007	0,003	0,006	0,002	0,1%
50th	0,002	0,001	0,002	0,001	0,1%
THD		0,042		0,041	5%

Note:

Inverter shall be connected to test circuit Figure C1 (AS4777.2), Grid nominal voltage within +/-5%, AC-Frequency 50+/-1Hz and Phase angle between 3 phases shall be 120+/-1.5°. Via DC-input set AC-output power (VA) so that it equals to 100+/-5% of rated output. Harmonic ratios of the test voltage shall be measured. Limits based on percentage of fundamental! Total harmonic distortion to the 50th harmonic 5%.

The tests had been performed on the SOFAR 1100TL and SOFAR 3000TL are valid for the SOFAR 1600TL, SOFAR 2200TL, SOFAR 2700TL, since it is identical in hardware and just power derated by software.

5.7 Voltage Fluctuations and Flicker			P
SOFAR 1100TL			
Phase 1			
Limit	Pst = 1,0	Plt = 0,65	
Test value	0,07	0,07	
SOFAR 3000TL			
Phase 1			
Limit	Pst = 1,0	Plt = 0,65	
Test value	0,07	0,07	
<p>Note:</p> <p>The inverter shall conform to the voltage fluctuation and flicker limits specified in AS/NZS 61000.3.3 for equipment with rated current less than or equal to 16 A per phase (a.c.). For equipment with rated current greater than 16 A per phase (a.c.), if the inverter cannot meet the requirements of AS/NZS 61000.3.3, the maximum permissible connection point impedance (Z_{max}) shall be determined such that the voltage fluctuation and flicker limits specified in AS/NZS 61000.3.3 can be met. The impedance shall be determined in accordance with the methods given in AS/NZS 61000.3.11. For test results see Annex 1 – EMC Report.</p> <p>The tests had been performed on the SOFAR 1100TL and SOFAR 3000TL are valid for the SOFAR 1600TL, SOFAR 2200TL, SOFAR 2700TL, since it is identical in hardware and just power derated by software.</p>			

5.8 Transient Voltage Limits (phase to neutral) Appendix D Transient Voltage Limit Test						P
	10+/-5% Output Power (VA)		50+/-5% Output Power (VA)		100+/-5% Output Power (VA)	
	Duration (s)	Line to neutral (V)	Duration (s)	Line to neutral (V)	Duration (s)	Line to neutral (V)
Limit	0,002	580	0,002	580	0,002	580
Test value	0,002	338,2	0,002	231,6	0,002	312,5
Limit	0,006	470	0,006	470	0,006	470
Test value	0,006	136,0	0,006	378,7	0,006	309,4
Limit	0,02	420	0,02	420	0,02	420
Test value	0,02	356,6	0,02	294,1	0,02	303,1
Limit	>0,06	390	>0,06	390	>0,06	390
Test value	0,06	286,7	0,06	279,4	0,06	290,6

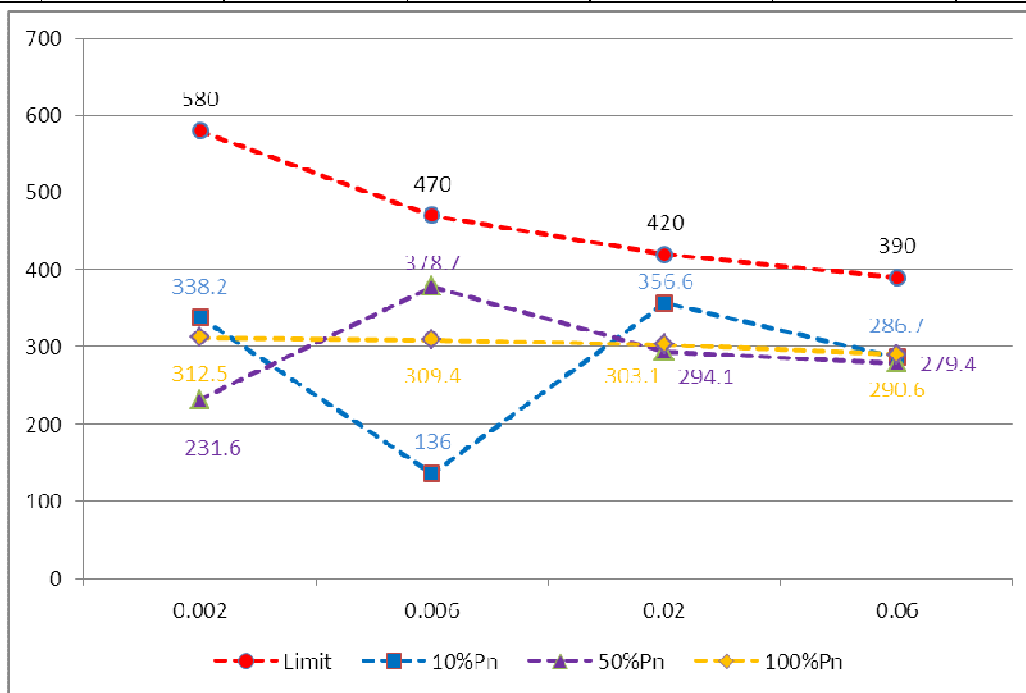

Note:

Results shall not exceed limits in Table 4 of AS/NZS 4777.2. Test Specifications: Inverter shall be connected to test circuit AS/NZS 4777.2 Figure D1. Grid nominal voltage within +/-5%, Via DC-input set AC- output power so that it equals to 10+/-5% of rated output (VA). Switch S shall be opened and the output voltage duration (Sample frequency of at least 10kHz) of the inverter shall be recorded. Test shall be repeated at 50+/-5% and 100+/-5% of rated output power.

The tests had been performed on the SOFAR 3000TL is valid for the SOFAR 1100TL, SOFAR 1600TL, SOFAR 2200TL, SOFAR 2700TL, since it is identical in hardware and just power derated by software.

5.9 Direct current injection Appendix E D.C. injection test							P
SOFAR 1100TL							
Testing at 20+/-5% Output Power							
Phases	L1-L1 (mA)	L1-L2 (mA)	L1-L3 (mA)	L2-L3 (mA)	L1-N (mA)	L2-N (mA)	L3-N (mA)
Test value	Single phase!	Single phase!	Single phase!	Single phase!	16,0	Single phase!	Single phase!
Testing at 60+/-5% Output Power							
Phases	L1-L1 (mA)	L1-L2 (mA)	L1-L3 (mA)	L2-L3 (mA)	L1-N (mA)	L2-N (mA)	L3-N (mA)
Test value	Single phase!	Single phase!	Single phase!	Single phase!	16,0	Single phase!	Single phase!
Testing at 100+/-5% Output Power							
Phases	L1-L1 (mA)	L1-L2 (mA)	L1-L3 (mA)	L2-L3 (mA)	L1-N (mA)	L2-N (mA)	L3-N (mA)
Test value	Single phase!	Single phase!	Single phase!	Single phase!	17,0	Single phase!	Single phase!

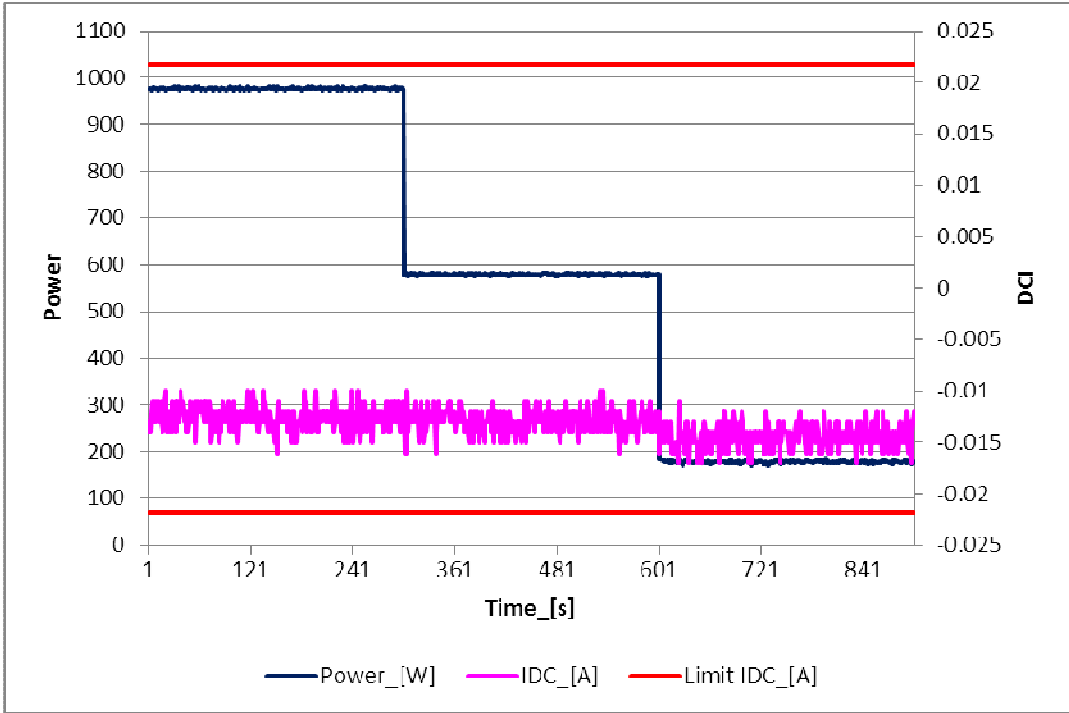

The graph displays three data series over time (0 to 841 seconds):
- **Power [W]** (blue line): Starts at ~1000W, drops to ~600W at 361s, and then to ~200W at 601s.
- **IDC [A]** (magenta line): Shows high-frequency noise fluctuating around 0A.
- **Limit IDC [A]** (red lines): Two horizontal lines at approximately 0.022A and -0.022A.

SOFAR 3000TL							
Testing at 20+/-5% Output Power							
Phases	L1-L1 (mA)	L1-L2 (mA)	L1-L3 (mA)	L2-L3 (mA)	L1-N (mA)	L2-N (mA)	L3-N (mA)
Test value	Single phase!	Single phase!	Single phase!	Single phase!	61,0	Single phase!	Single phase!
Testing at 60+/-5% Output Power							
Phases	L1-L1 (mA)	L1-L2 (mA)	L1-L3 (mA)	L2-L3 (mA)	L1-N (mA)	L2-N (mA)	L3-N (mA)
Test value	Single phase!	Single phase!	Single phase!	Single phase!	60,0	Single phase!	Single phase!
Testing at 100+/-5% Output Power							
Phases	L1-L1 (mA)	L1-L2 (mA)	L1-L3 (mA)	L2-L3 (mA)	L1-N (mA)	L2-N (mA)	L3-N (mA)
Test value	Single phase!	Single phase!	Single phase!	Single phase!	62,0	Single phase!	Single phase!

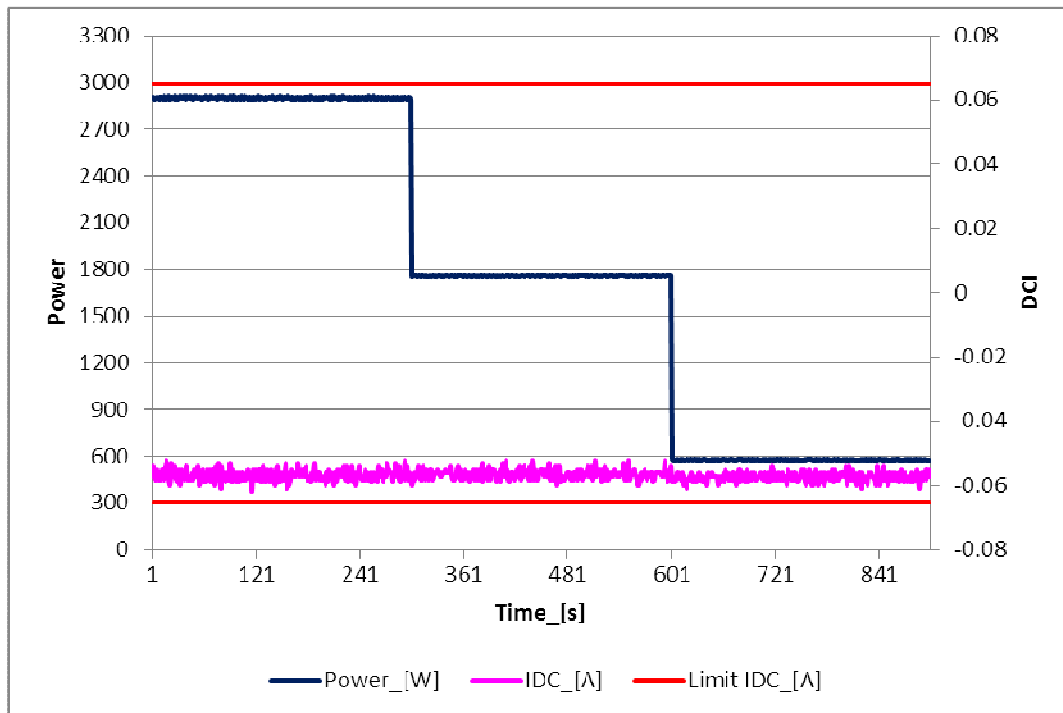

Note:

In the case of a single-phase inverter: not exceed 0.5% of the inverter's rated current or 5 mA, whichever is the greater.

In the case of a three-phase inverter: shall not exceed 0.5% of the inverter's per-phase rated current or 5 mA, whichever is the greater.

The tests had been performed on the SOFAR 1100TL and SOFAR 3000TL are valid for the SOFAR 1600TL, SOFAR 2200TL, SOFAR 2700TL, since it is identical in hardware and just power derated by software.

6.2 Inverter demand response modes (DRMs) Appendix I Demand and power quality response					P
Mode	Requirement	Measurement			Result
		Real current (A)	Reactive current (A)	Switching Time (s)	
DRM 0	Operate the disconnection device	12,524	0,448	0,944	P
DRM 1	Do not consume power	N/A	N/A	N/A	N/A
DRM 2	Do not consume at more than 50% of rated power	N/A	N/A	N/A	N/A
DRM 1 and DRM 2		N/A	N/A	N/A	N/A
DRM 3	Do not consume at more than 75% of rated power AND Source reactive power if capable	N/A	N/A	N/A	N/A
DRM 2 and DRM 3		N/A	N/A	N/A	N/A
DRM 4	Increase power consumption (subject to constraints from other active DRMs)	N/A	N/A	N/A	N/A
DRM 5	Do not generate power	N/A	N/A	N/A	N/A
DRM 6	Do not generate at more than 50% of rated power	N/A	N/A	N/A	N/A
DRM 5 and DRM 6		N/A	N/A	N/A	N/A
DRM 7	Do not generate at more than 75% of rated power AND Sink reactive power if capable	N/A	N/A	N/A	N/A
DRM 6 and DRM 7		N/A	N/A	N/A	N/A
DRM 8	Increase power generation (subject to constraints from other active DRMs)	N/A	N/A	N/A	N/A
<p>Note: Switching time limit : 2s</p> <p>The tests had been performed on the SOFAR 3000TL is valid for the SOFAR 1100TL, SOFAR 1600TL, SOFAR 2200TL, SOFAR 2700TL, since it is identical in hardware and just power derated by software.</p>					

6.3.2.2 Volt-watt response mode (Australia Default Setting)	P
--	----------

Test value	a) V1	b) V2	c) V3	d) V4
Voltage (V)	207,3	220,0	250,1	265,1
P (W)	2968,1	2994,2	2888,6	593,2
P/P _{rated} (%)	98,94	99,81	96,29	19,77

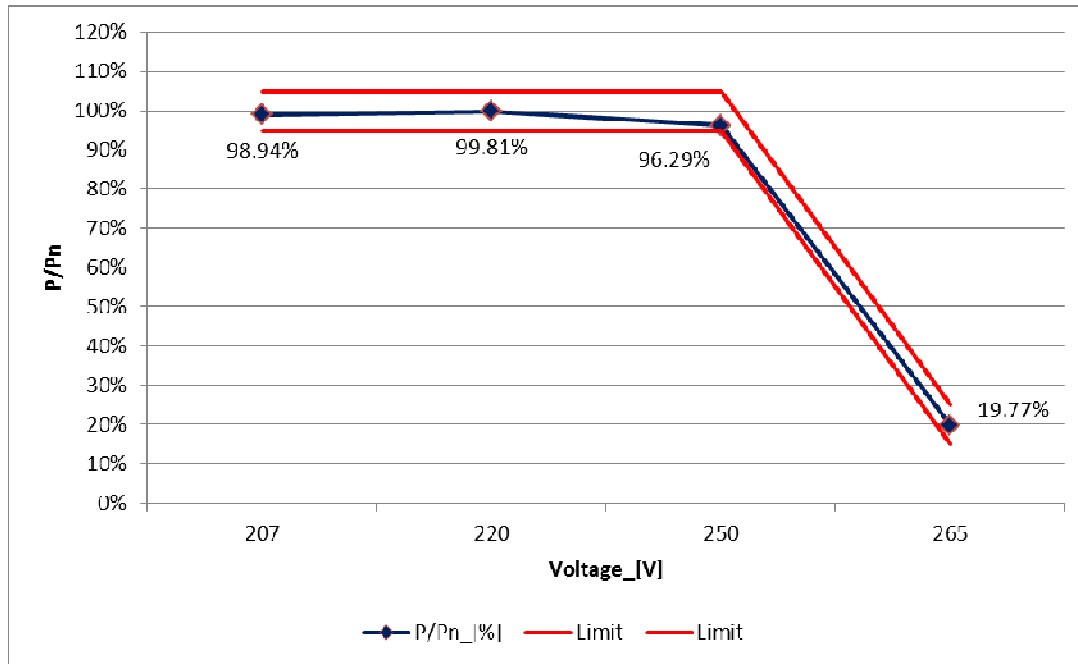

Note:

The tests had been performed on the SOFAR 3000TL is valid for the SOFAR 1100TL, SOFAR 1600TL, SOFAR 2200TL, SOFAR 2700TL, since it is identical in hardware and just power derated by software.

6.3.2.2 Volt-watt response mode (New Zealand Default Setting)	P
--	----------

Test value	a) V1	b) V2	c) V3	d) V4
Voltage (V)	207,2	220,1	244,1	255,0
P (W)	2,966	2,993	2,940	0,606
P/P _{rated} (%)	98,86	99,78	98,01	20,19

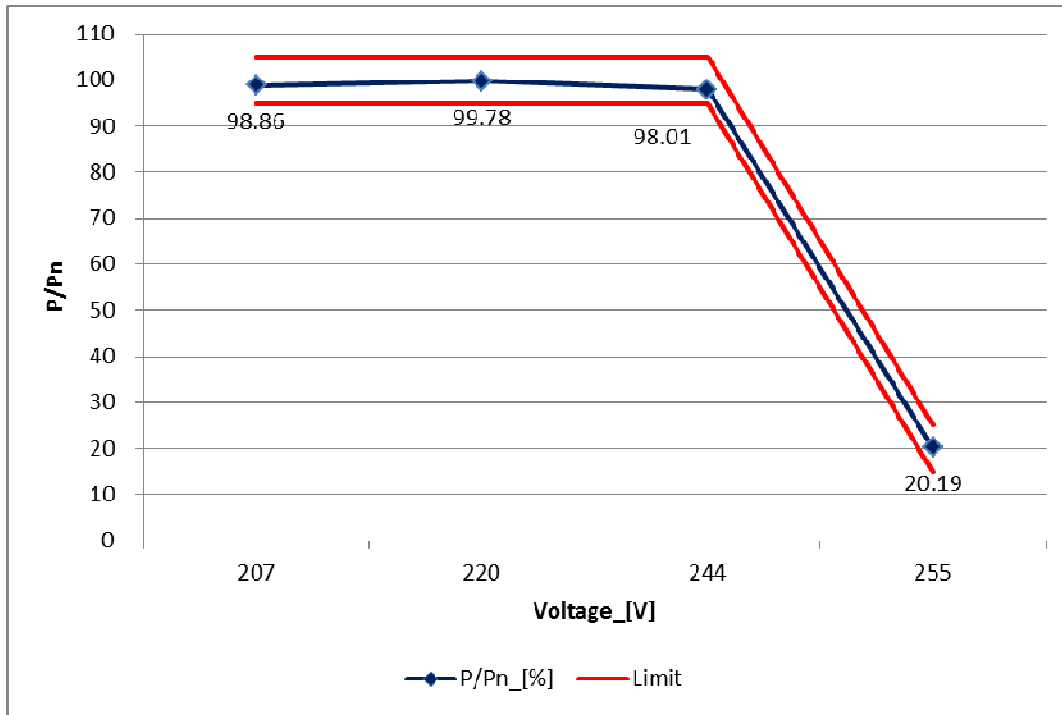

Note:

The tests had been performed on the SOFAR 3000TL is valid for the SOFAR 1100TL, SOFAR 1600TL, SOFAR 2200TL, SOFAR 2700TL, since it is identical in hardware and just power derated by software.

6.3.5 Power rate limit	P
-------------------------------	----------

6.3.5.3.2 Test (a): Soft ramp up after connect or reconnect

Time measurement from 0% to 100% P_{rated} (min)	353 s
W_{Gra}	8,5W
Limit W_{Gra} : (Default : 16,67%)	17%

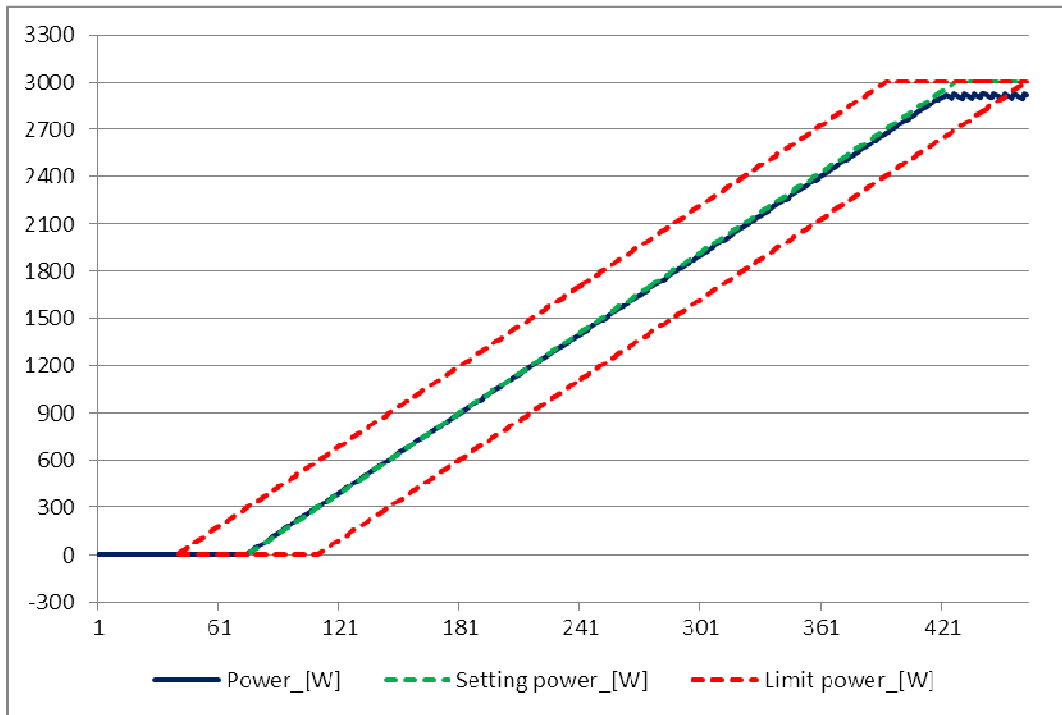

6.3.5.3.3 Test (b): Change in a.c. operation and control (DRM control only)

DRM mode	N/A	N/A
Power change (%)	Increase: _____% to _____%	Decrease: _____% to _____%
Time measurement	N/A	N/A
W_{Gra}	N/A	N/A
Limit W_{Gra} : (Default : 16,67%)	N/A	N/A

N/A

6.3.5.3.4 Test (c): Change in energy source operation (only for multiple mode inverters with energy storage)

DRM mode	DRM 0	N/A
Power change	Increase: <u> 0 </u> % to <u> 100 </u> %	Decrease: _____% to _____%
Time measurement	353 s	N/A
W_{Gra}	8,5	N/A

Limit W_{Gra} : (Default : 16,67%)	17%	N/A
N/A		
6.3.5.4 Nonlinearity of power rate limit changes		
DRM mode	N/A	N/A
Power change	Increase: _____% to _____%	Decrease: _____% to _____%
Time measurement	N/A	N/A
W_{Gra}	N/A	N/A
Limit W_{Gra} : (Default : 16,67%)	N/A	N/A
N/A		
Note:		
The tests had been performed on the SOFAR 3000TL is valid for the SOFAR 1100TL, SOFAR 1600TL, SOFAR 2200TL, SOFAR 2700TL, since it is identical in hardware and just power derated by software.		

7.3 Active anti-islanding protection
Appendix F Active anti-islanding test

F3 Test under load condition A = Light Electronic Load

P

Inverter output Power	Approx. Inverter power (kW)	Time to trip (Average in Sec)	Disconnection Limit (in sec)
10+/-5%	0,280	0,570	2s
50+/-5%	1,467	0,466	2s
100+/-5%	2,980	0,514	2s

Light electronic load:

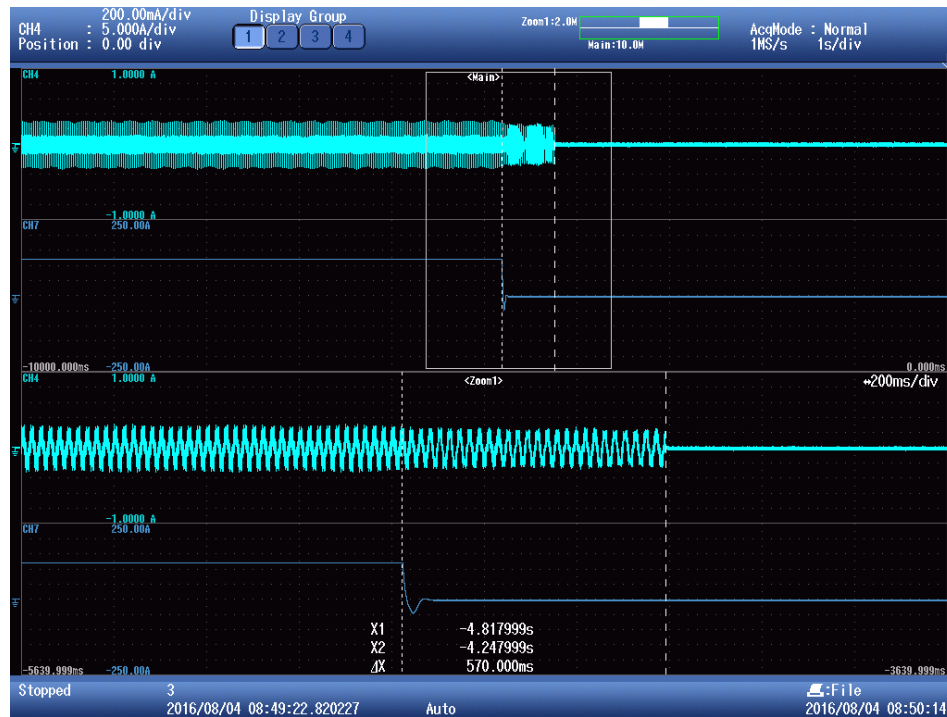

Light Electronic Load:

Test circuit according to AS 4777.2 Annex F (Figure F1 and F2). Grid voltage equal to nominal load. Via dc input control ac output power so that it equals to 10+/-5% of rated output. Switch S shall be opened and time interval for the inverter being disconnected shall be recorded. Same procedure for 50+/-5% and 100+/-5%.

The load of Figure F2 is used for the inverters with rated apparent power not more than 5kVA.

For other inverters, the resistor load of Figure 2 equal to 0,1% of rated apparent power.

The tests had been performed on the SOFAR 3000TL is valid for the SOFAR 1100TL, SOFAR 1600TL, SOFAR 2200TL, SOFAR 2700TL, since it is identical in hardware and just power derated by software.

7.3 Active anti-islanding protection
Appendix F Active anti-islanding test

F4 Test under load condition B = Load match

P

Inverter output Power	Approx. Inverter power (kW)	Time to trip (Average in Sec)	Disconnection Limit (in sec)
10+/-5%	0,280	0,500	2s
50+/-5%	1,467	0,519	2s
100+/-5%	2,980	0,487	2s

Load match:

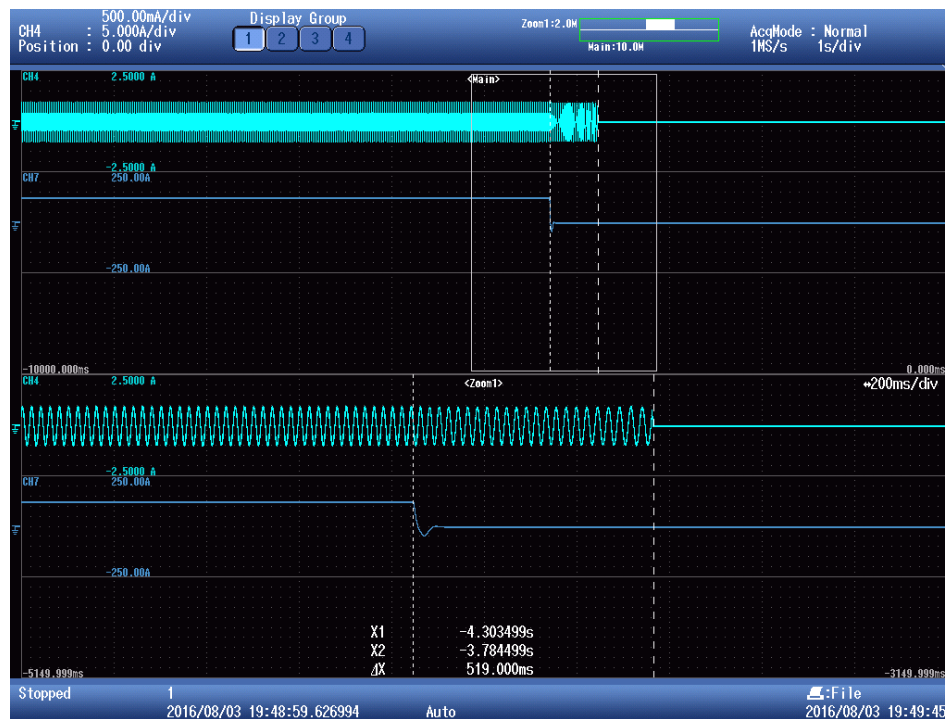

Load match:

Test circuit according to AS 4777.2 Annex F (Figure F1 and F3) Grid voltage equal to nominal load +/-5%, R shall match real power output, L and C shall draw reactive power according to Table F1. Via dc input control ac output power so that it equals to 10+/-5% of rated output. R shall be in- or decreased until resonant load matches real power output to within +/-5%. Inductive or capacitive load shall be adjusted until reactive power consumption matches the reactive power output of the inverter to within +/-5%. Switch S shall be opened and time interval of the inverter being disconnected shall be recorded. Same procedure for 50+/-5% and 100+/-5%.

The tests had been performed on the SOFAR 3000TL is valid for the SOFAR 1100TL, SOFAR 1600TL, SOFAR 2200TL, SOFAR 2700TL, since it is identical in hardware and just power derated by software.

7.3 Active anti-islanding protection
Appendix F Active anti-islanding test

F5 Test under load condition B = Load match + 10%

Inverter output Power	Approx. Inverter power (kW)	Time to trip (Average in Sec)	Disconnection Limit (in sec)
10+/-5%	0,280	0,777	2s
50+/-5%	1,467	0,500	2s
100+/-5%	2,980	0,509	2s

Load match + 10%:

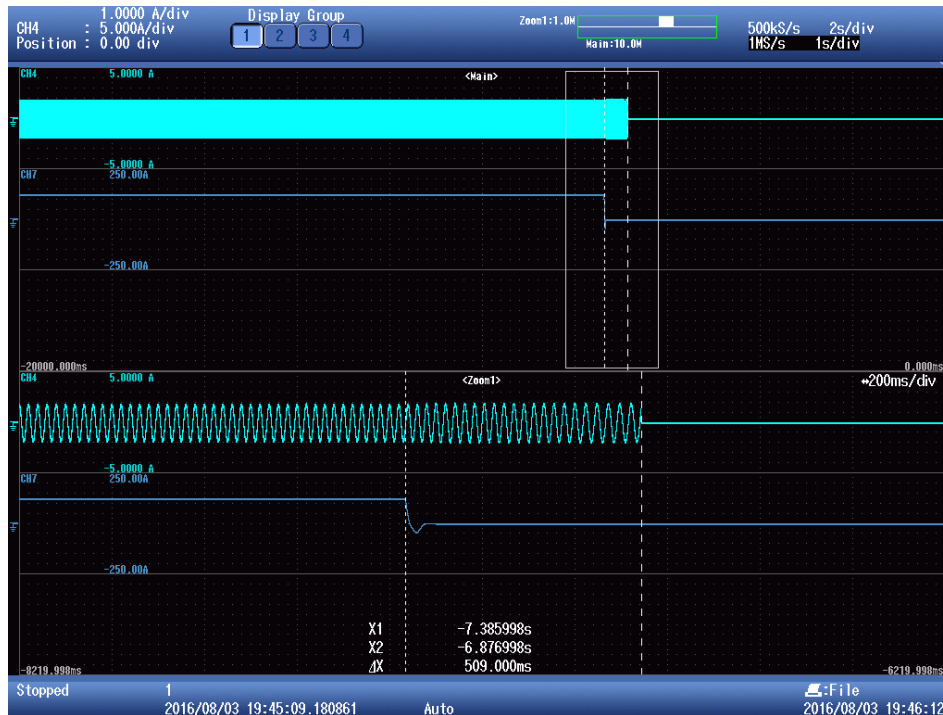

Load match + 10%:

Test circuit according to AS 4777.2 Annex F (Figure F1 and F3) Grid voltage equal to nominal load +/-5%, R shall match real power output, L and C shall draw reactive power according to Table F1. Via dc input control ac output power so that it equals to 10+/-5% of rated output. R shall be in- or decreased until resonant load matches real power output to within +/-5%. Inductive or capacitive load shall be adjusted until reactive power consumption matches the reactive power output of the inverter to within +/-5%. Switch S shall be opened and time interval of the inverter being disconnected shall be recorded. Same procedure for 50+/-5% and 100+/-5%.

The tests had been performed on the SOFAR 3000TL is valid for the SOFAR 1100TL, SOFAR 1600TL, SOFAR 2200TL, SOFAR 2700TL, since it is identical in hardware and just power derated by software.

7.3 Active anti-islanding protection IEC 62116 Active anti-islanding test Load imbalance (real, reactive load) for test condition A (EUT output = 100%)									P
SOFAR 1600TL									
Test conditions		Frequency: 50+/-0,1Hz U _N =230+/-3Vac RLC consumes inverter real power within +/- 3% Distortion factor of chokes < 3% Quality =1							
Disconnection limit		0,5s							
No	P _{EUT} ¹⁾ (% of EUT rating)	Reactive load (% of Q _L in 6.1.d) 1)	P _{AC} ²⁾ (% of nominal)	Q _{AC} ³⁾ (% of nominal)	Run on Time (ms)	P _{EUT} (W)	Qf	V _{DC}	Remarks ⁴⁾
1	100	100	0	0	370	1499	1,02	340,5	Test A at BL
4	100	100	-5	-5	353	1499	0,94	340,5	Test A at IB
5	100	100	-5	0	303	1499	0,97	340,5	Test A at IB
6	100	100	-5	+5	286	1499	0,99	340,5	Test A at IB
7	100	100	0	-5	285	1499	0,99	340,5	Test A at IB
8	100	100	0	+5	348	1499	1,04	340,5	Test A at IB
9	100	100	+5	-5	369	1499	1,04	340,5	Test A at IB
10	100	100	+5	0	301	1499	1,07	340,5	Test A at IB
11	100	100	+5	+5	347	1499	1,10	340,5	Test A at IB
Parameter at 0%		L= 108,71 mH		R= 35,29 Ω		C= 90,26 μF			
Indicate additional shut down time included in above results. (Disconnection device operation time)								20ms	
<p>Note: Note for technologies which have a substantial shut down time this can be added to the 0.5 seconds in establishing that the trip occurred in less than 0.5s. Maximum shut down time could therefore be up to 1.0 seconds for these technologies. RLC is adjusted to min. +/-1% of the inverter rated output power</p> <p>1) P_{EUT}: EUT output power 2) P_{AC}: Real power flow at S1 in Figure 1. Positive means power from EUT to utility. Nominal is the 0 % test condition value. 3) Q_{AC}: Reactive power flow at S1 in Figure 1. Positive means power from EUT to utility. Nominal is the 0 % test condition value. 4) BL: Balance condition, IB: Imbalance condition. Condition A: EUT output power P_{EUT} = Maximum⁵⁾ EUT input voltage⁶⁾ = >90% of rated input voltage range 5) Maximum EUT output power condition should be achieved using the maximum allowable input power. Actual output power may exceed nominal rated output. 6) Based on EUT rated input operating range. For example, If range is between X volts and Y volts, 90 % of range =X + 0,9 × (Y – X). Y shall not exceed 0,8 × EUT maximum system voltage (i.e., maximum allowable array open circuit voltage). In any case, the EUT should not be operated outside of its allowable input voltage range.</p>									

The tests had been performed on the SOFAR 3000TL and SOFAR 1600TL are valid for the SOFAR 1100TL, SOFAR 2200TL, SOFAR 2700TL, since it is identical in hardware and just power derated by software.

The test result refer to the test report "PVUK140508N005" issued by Bureau Veritas Shenzhen Co., Ltd. Dongguan Branch on July 22, 2014

Disconnection at P_{AC} 0% and Q_{AC} 0% reactive load and 100% nominal power

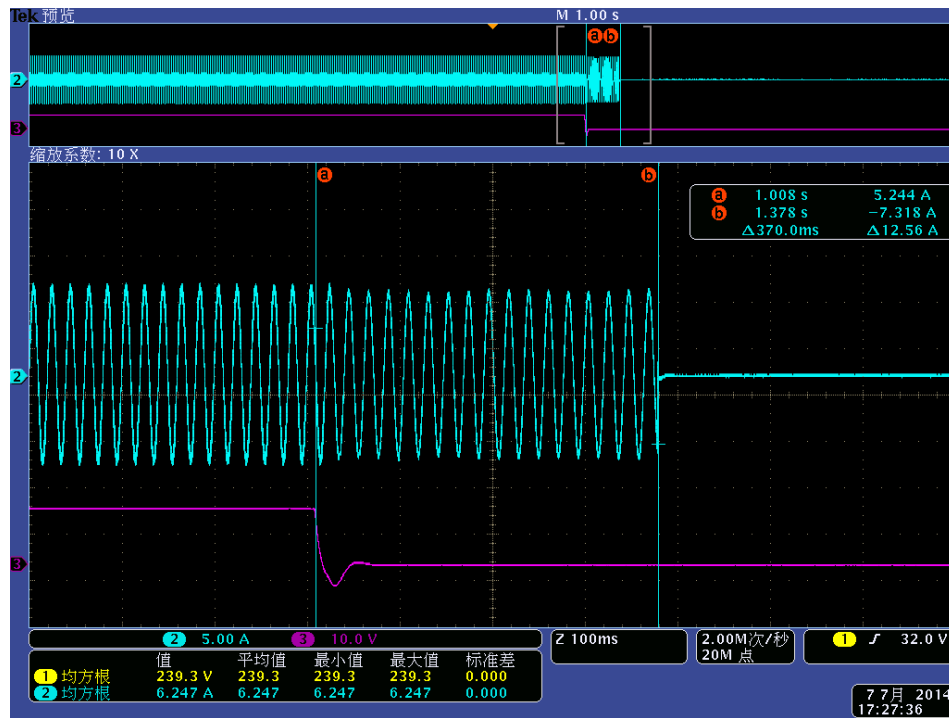

7.3 Active anti-islanding protection IEC 62116 Active anti-islanding test Load imbalance (reactive load) for test condition B (EUT output = 50 % – 66 %)									P
SOFAR 1600TL									
Test conditions		Frequency: 50+/-0,1Hz U _N =230+/-3Vac RLC consumes inverter real power within +/- 3% Distortion factor of chokes < 3% Quality =1							
Disconnection limit		0,5s							
No	P _{EUT} ¹⁾ (% of EUT rating)	Reactive load (% of Q _L in 6.1.d) 1)	P _{AC} ²⁾ (% of nominal)	Q _{AC} ³⁾ (% of nominal)	Run on Time (ms)	P _{EUT} (W)	Qf	V _{DC}	Remarks ⁴⁾
12	66	66	0	-5	356	912	1,00	262,5	Test B at IB
13	66	66	0	-4	347	912	1,00	262,5	Test B at IB
14	66	66	0	-3	407	912	1,01	262,5	Test B at IB
15	66	66	0	-2	443	912	1,01	262,5	Test B at IB
16	66	66	0	-1	333	912	1,02	262,5	Test B at IB
2	66	66	0	0	379	912	1,02	262,5	Test B at BL
17	66	66	0	1	426	912	1,03	262,5	Test B at IB
18	66	66	0	2	389	912	1,03	262,5	Test B at IB
19	66	66	0	3	330	912	1,04	262,5	Test B at IB
20	66	66	0	4	448	912	1,04	262,5	Test B at IB
21	66	66	0	5	303	912	1,05	262,5	Test B at IB
Parameter at 0%			L= 177,44 mH		R= 58,00 Ω		C= 55,24 μF		
Indicate additional shut down time included in above results. (Disconnection device operation time)								20ms	
Note: RLC is adjusted to min. +/-1% of the inverter rated output power 1) P _{EUT} : EUT output power 2) P _{AC} : Real power flow at S1 in Figure 1. Positive means power from EUT to utility. Nominal is the 0 % test condition value. 3) Q _{AC} : Reactive power flow at S1 in Figure 1. Positive means power from EUT to utility. Nominal is the 0 % test condition value. 4) BL: Balance condition, IB: Imbalance condition. Condition B: EUT output power P _{EUT} = 50 % – 66 % of maximum EUT input voltage ⁵⁾ = 50 % of rated input voltage range, ±10 % 5) Based on EUT rated input operating range. For example, If range is between X volts and Y volts, 50 % of range = X + 0,5 × (Y – X). Y shall not exceed 0,8 × EUT maximum system voltage (i.e., maximum allowable array open circuit voltage). In any case, the EUT should not be operated outside of its allowable input voltage range.									

The tests had been performed on the SOFAR 3000TL and SOFAR 1600TL are valid for the SOFAR 1100TL, SOFAR 2200TL, SOFAR 2700TL, since it is identical in hardware and just power derated by software.

The test result refer to the test report " PVUK140508N005" issued by Bureau Veritas Shenzhen Co., Ltd. Dongguan Branch on July 22, 2014

Disconnection at P_{AC} 0% and Q_{AC} 4% reactive load and 66% nominal power

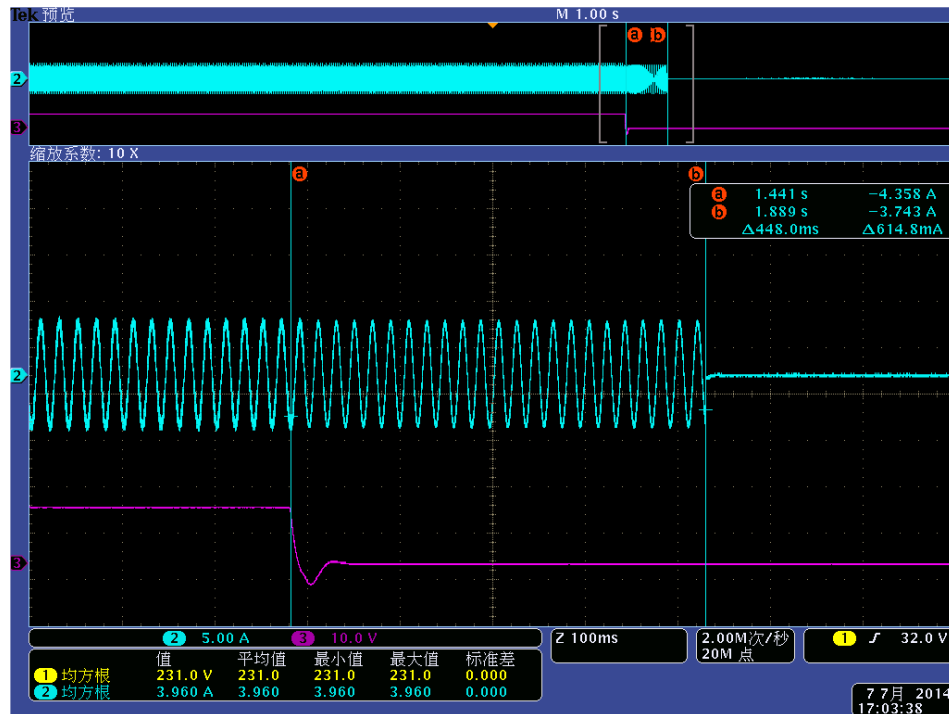

7.3 Active anti-islanding protection IEC 62116 Active anti-islanding test Load imbalance (reactive load) for test condition C (EUT output = 25 % – 33 %)									P
SOFAR 1600TL									
Test conditions		Frequency: 50+/-0,1Hz $U_N=230\pm 3V_{ac}$ RLC consumes inverter real power within +/- 3% Distortion factor of chokes < 3% Quality =1							
Disconnection limit		0,5s							
No	$P_{EUT}^{1)}$ (% of EUT rating)	Reactive load (% of Q_L in 6.1.d) 1)	$P_{AC}^{2)}$ (% of nominal)	$Q_{AC}^{3)}$ (% of nominal)	Run on Time (ms)	P_{EUT} (W)	Qf	V_{DC}	Remarks ⁴⁾
22	33	33	0	-5	349	439	0,99	184,5	Test C at IB
23	33	33	0	-4	361	439	1,00	184,5	Test C at IB
24	33	33	0	-3	397	439	1,00	184,5	Test C at IB
25	33	33	0	-2	389	439	1,01	184,5	Test C at IB
26	33	33	0	-1	352	439	1,01	184,5	Test C at IB
3	33	33	0	0	325	439	1,02	184,5	Test C at BL
27	33	33	0	1	357	439	1,02	184,5	Test C at IB
28	33	33	0	2	327	439	1,03	184,5	Test C at IB
29	33	33	0	3	306	439	1,03	184,5	Test C at IB
30	33	33	0	4	349	439	1,04	184,5	Test C at IB
31	33	33	0	5	310	439	1,04	184,5	Test C at IB
Parameter at 0%			L= 370,08 mH		R= 120,50 Ω		C= 26,36 μF		
Indicate additional shut down time included in above results. (Disconnection device operation time)								20ms	
<p>Note: RLC is adjusted to min. +/-1% of the inverter rated output power ¹⁾ P_{EUT}: EUT output power ²⁾ P_{AC}: Real power flow at S1 in Figure 1. Positive means power from EUT to utility. Nominal is the 0 % test condition value. ³⁾ Q_{AC}: Reactive power flow at S1 in Figure 1. Positive means power from EUT to utility. Nominal is the 0 % test condition value. ⁴⁾ BL: Balance condition, IB: Imbalance condition. Condition C: EUT output power $P_{EUT} = 25 \% - 33 \%$ ⁵⁾ of maximum EUT input voltage ⁶⁾ = <10 % of rated input voltage range ⁵⁾ Or minimum allowable EUT output level if greater than 33 %. ⁶⁾ Based on EUT rated input operating range. For example, If range is between X volts and Y volts, 10 % of range = $X + 0,1 \times (Y - X)$. Y shall not exceed $0,8 \times$ EUT maximum system voltage (i.e., maximum allowable array open circuit voltage). In any case, the EUT should not be operated outside of its allowable input voltage range.</p>									

The tests had been performed on the SOFAR 3000TL and SOFAR 1600TL are valid for the SOFAR 1100TL, SOFAR 2200TL, SOFAR 2700TL, since it is identical in hardware and just power derated by software.

The test result refer to the test report "PVUK140508N005" issued by Bureau Veritas Shenzhen Co., Ltd. Dongguan Branch on July 22, 2014

Disconnection at P_{AC} 0%? and Q_{AC} -3% reactive load and 33% nominal power

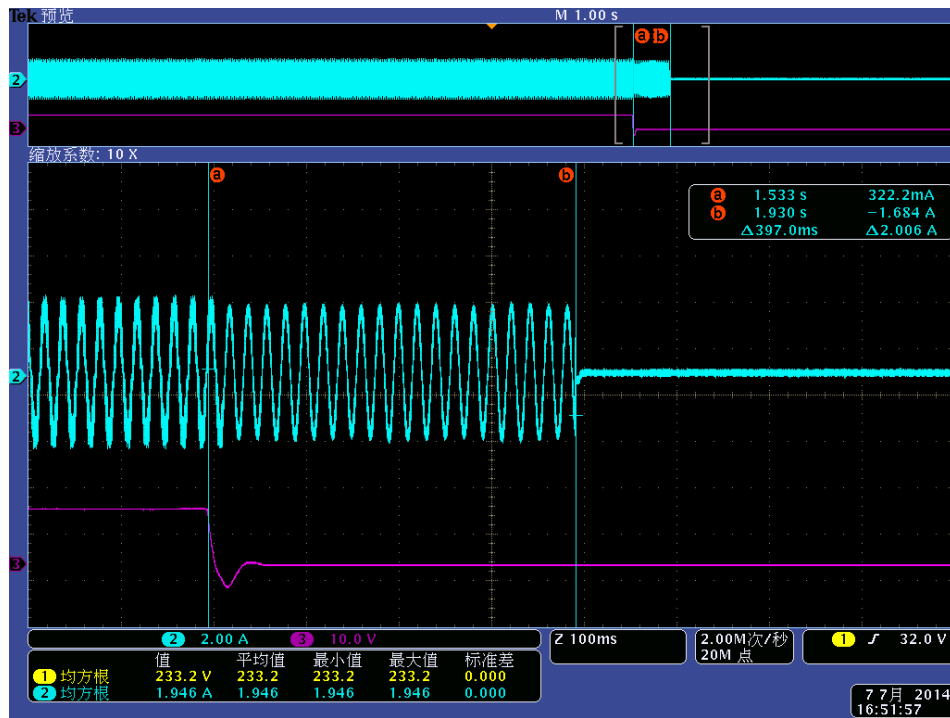

7.3 Active anti-islanding protection IEC 62116 Active anti-islanding test Load imbalance (real, reactive load) for test condition A (EUT output = 100%)								P	
SOFAR 3000TL									
Test conditions			Frequency: 50+/-0,1Hz $U_N=230\pm 3V_{ac}$ RLC consumes inverter real power within +/- 3% Distortion factor of chokes < 3% Quality = 1						
Disconnection limit			0,5s						
No	$P_{EUT}^{1)}$ (% of EUT rating)	Reactive load (% of Q_L in 6.1.d 1)	$P_{AC}^{2)}$ (% of nominal)	$Q_{AC}^{3)}$ (% of nominal)	Run on Time (ms)	P_{EUT} (W)	Qf	V_{DC}	Remarks ⁴⁾
1	100	100	0	0	486	2821	1,00	383	Test A at BL
4	100	100	-5	-5	150	2821	0,93	383	Test A at IB
5	100	100	-5	0	404	2821	0,95	383	Test A at IB
6	100	100	-5	+5	86	2821	0,97	383	Test A at IB
7	100	100	0	-5	195	2821	0,97	383	Test A at IB
8	100	100	0	+5	64	2821	1,02	383	Test A at IB
9	100	100	+5	-5	54	2821	1,02	383	Test A at IB
10	100	100	+5	0	234	2821	1,05	383	Test A at IB
11	100	100	+5	+5	122	2821	1,08	383	Test A at IB
Parameter at 0%			L= 59,84 mH		R= 18,75 Ω		C= 169,75 μF		
Indicate additional shut down time included in above results. (Disconnection device operation time)								20ms	
<p>Note: Note for technologies which have a substantial shut down time this can be added to the 0.5 seconds in establishing that the trip occurred in less than 0.5s. Maximum shut down time could therefore be up to 1.0 seconds for these technologies. RLC is adjusted to min. +/-1% of the inverter rated output power ¹⁾ P_{EUT}: EUT output power ²⁾ P_{AC}: Real power flow at S1 in Figure 1. Positive means power from EUT to utility. Nominal is the 0 % test condition value. ³⁾ Q_{AC}: Reactive power flow at S1 in Figure 1. Positive means power from EUT to utility. Nominal is the 0 % test condition value. ⁴⁾ BL: Balance condition, IB: Imbalance condition. Condition A: EUT output power $P_{EUT} = \text{Maximum}^5)$ EUT input voltage ⁶⁾ = >90% of rated input voltage range ⁵⁾ Maximum EUT output power condition should be achieved using the maximum allowable input power. Actual output power may exceed nominal rated output. ⁶⁾ Based on EUT rated input operating range. For example, If range is between X volts and Y volts, 90 % of range = $X + 0,9 \times (Y - X)$. Y shall not exceed $0,8 \times$ EUT maximum system voltage (i.e., maximum allowable array open circuit voltage). In any case, the EUT should not be operated outside of its allowable input voltage range.</p>									

The tests had been performed on the SOFAR 3000TL and SOFAR 1600TL are valid for the SOFAR 1100TL, SOFAR 2200TL, SOFAR 2700TL, since it is identical in hardware and just power derated by software.

The test result refer to the test report "PVUK140508N005" issued by Bureau Veritas Shenzhen Co., Ltd. Dongguan Branch on July 22, 2014

Disconnection at P_{AC} 0% and Q_{AC} 0% reactive load and 100% nominal power

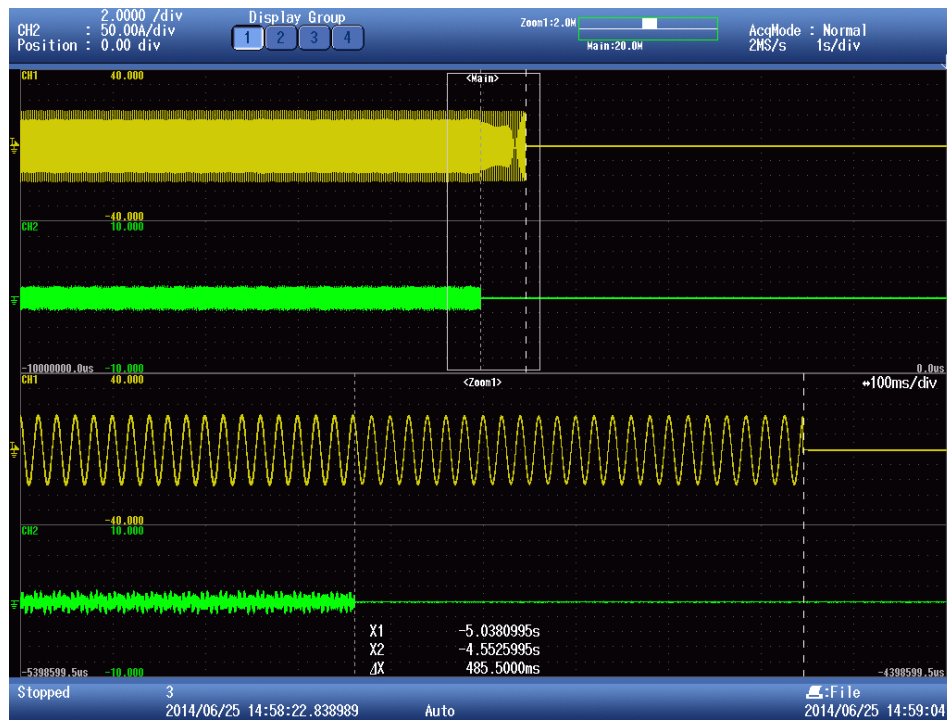

7.3 Active anti-islanding protection IEC 62116 Active anti-islanding test Load imbalance (reactive load) for test condition B (EUT output = 50 % – 66 %)									P
SOFAR 3000TL									
Test conditions			Frequency: 50+/-0,1Hz U _N =230+/-3Vac RLC consumes inverter real power within +/- 3% Distortion factor of chokes < 3% Quality =1						
Disconnection limit			0,5s						
No	P _{EUT} ¹⁾ (% of EUT rating)	Reactive load (% of Q _L in 6.1.d) 1)	P _{AC} ²⁾ (% of nominal)	Q _{AC} ³⁾ (% of nominal)	Run on Time (ms)	P _{EUT} (W)	Qf	V _{DC}	Remarks ⁴⁾
32	66	66	0	-6	95	1771	0,97	315	Test B at IB
12	66	66	0	-5	116	1771	0,98	315	Test B at IB
13	66	66	0	-4	95	1771	0,98	315	Test B at IB
14	66	66	0	-3	131	1771	0,99	315	Test B at IB
15	66	66	0	-2	150	1771	0,99	315	Test B at IB
16	66	66	0	-1	233	1771	1,00	315	Test B at IB
2	66	66	0	0	477	1771	1,00	315	Test B at BL
17	66	66	0	1	200	1771	1,01	315	Test B at IB
18	66	66	0	2	387	1771	1,01	315	Test B at IB
19	66	66	0	3	165	1771	1,02	315	Test B at IB
20	66	66	0	4	217	1771	1,02	315	Test B at IB
21	66	66	0	5	139	1771	1,03	315	Test B at IB
Parameter at 0%			L= 94,92 mH		R= 29,87 Ω		C= 106,93 μF		
Indicate additional shut down time included in above results. (Disconnection device operation time)								20ms	
<p>Note: RLC is adjusted to min. +/-1% of the inverter rated output power 1) P_{EUT}: EUT output power 2) P_{AC}: Real power flow at S1 in Figure 1. Positive means power from EUT to utility. Nominal is the 0 % test condition value. 3) Q_{AC}: Reactive power flow at S1 in Figure 1. Positive means power from EUT to utility. Nominal is the 0 % test condition value. 4) BL: Balance condition, IB: Imbalance condition. Condition B: EUT output power P_{EUT} = 50 % – 66 % of maximum EUT input voltage⁵⁾ = 50 % of rated input voltage range, ±10 % 5) Based on EUT rated input operating range. For example, If range is between X volts and Y volts, 50 % of range = X + 0,5 × (Y – X). Y shall not exceed 0,8 × EUT maximum system voltage (i.e., maximum allowable array open circuit voltage). In any case, the EUT should not be operated outside of its allowable input voltage range.</p>									

7.3 Active anti-islanding protection IEC 62116 Active anti-islanding test Load imbalance (reactive load) for test condition C (EUT output = 25 % – 33 %)									P
SOFAR 3000TL									
Test conditions		Frequency: 50+/-0,1Hz, U _N =230+/-3Vac RLC consumes inverter real power within +/- 3% Distortion factor of chokes < 3% Quality =1							
Disconnection limit		0,5s							
No	P _{EUT} ¹⁾ (% of EUT rating)	Reactive load (% of Q _L in 6.1.d) 1)	P _{AC} ²⁾ (% of nominal)	Q _{AC} ³⁾ (% of nominal)	Run on Time (ms)	P _{EUT} (W)	Qf	V _{DC}	Remarks ⁴⁾
33	33	33	0	-6	88	828	0,97	247	Test C at IB
22	33	33	0	-5	213	828	0,98	247	Test C at IB
23	33	33	0	-4	72	828	0,98	247	Test C at IB
24	33	33	0	-3	136	828	0,99	247	Test C at IB
25	33	33	0	-2	222	828	0,99	247	Test C at IB
26	33	33	0	-1	408	828	1,00	247	Test C at IB
3	33	33	0	0	499	828	1,00	247	Test C at BL
27	33	33	0	1	304	828	1,01	247	Test C at IB
28	33	33	0	2	184	828	1,01	247	Test C at IB
29	33	33	0	3	218	828	1,02	247	Test C at IB
30	33	33	0	4	100	828	1,02	247	Test C at IB
31	33	33	0	5	69	828	1,03	247	Test C at IB
Parameter at 0%		L= 202,14 mH		R= 63,89 Ω		C= 50,00 μF			
Indicate additional shut down time included in above results. (Disconnection device operation time)								20ms	
<p>Note: RLC is adjusted to min. +/-1% of the inverter rated output power ¹⁾ P_{EUT}: EUT output power ²⁾ P_{AC}: Real power flow at S1 in Figure 1. Positive means power from EUT to utility. Nominal is the 0 % test condition value. ³⁾ Q_{AC}: Reactive power flow at S1 in Figure 1. Positive means power from EUT to utility. Nominal is the 0 % test condition value. ⁴⁾ BL: Balance condition, IB: Imbalance condition. Condition C: EUT output power P_{EUT} = 25 % – 33 % ⁵⁾ of maximum EUT input voltage ⁶⁾ = <10 % of rated input voltage range ⁵⁾ Or minimum allowable EUT output level if greater than 33 %. ⁶⁾ Based on EUT rated input operating range. For example, If range is between X volts and Y volts, 10 % of range = X + 0,1 × (Y – X). Y shall not exceed 0,8 × EUT maximum system voltage (i.e., maximum allowable array open circuit voltage). In any case, the EUT should not be operated outside of its allowable input voltage range.</p>									

The tests had been performed on the SOFAR 3000TL and SOFAR 1600TL are valid for the SOFAR 1100TL, SOFAR 2200TL, SOFAR 2700TL, since it is identical in hardware and just power derated by software.

The test result refer to the test report "PVUK140508N005" issued by Bureau Veritas Shenzhen Co., Ltd. Dongguan Branch on July 22, 2014

Disconnection at P_{AC} 0% and Q_{AC} 0% reactive load and 33% nominal power



7.4 Voltage and frequency limits (passive anti-islanding protection) Appendix G2 Under- and over-voltage trip settings and reconnection test							P
Output Current level: 50+/-5% rated current							
Test	Under Voltage (V)			Time to disconnect (s) (Trip delay 1s)			Time to reconnect (s)
Limit	< 180 V			<=2s			>=60s
Actual setting	180,0			2,0			60,0
Trip value	180,6	180,4	180,2	1,920	1,920	1,930	79,0
Test	Over Voltage 1 (V)			Time to disconnect (s) (Trip delay 1s)			Time to reconnect (s)
Limit	> 260 V			<=2s			>=60s
Actual setting	260,0			2,0			60,0
Trip value	260,9	260,4	260,7	1,918	1,910	1,920	73,1
Test	Over Voltage 2 (V)			Time to disconnect (s)			Time to reconnect (s)
Limit	> 265 V			<=0,2s			>=60s
Actual setting	265,0			0,2			60,0
Trip value	265,4	265,9	265,4	0,076	0,087	0,085	67,0
Note: Actual settings are the settings of the inverter. The Trip value the measured value. It has to be in the range of $\pm 2V$ of the actual setting.							
The tests had been performed on the SOFAR 3000TL is valid for the SOFAR 1100TL, SOFAR 1600TL, SOFAR 2200TL, SOFAR 2700TL, since it is identical in hardware and just power derated by software.							

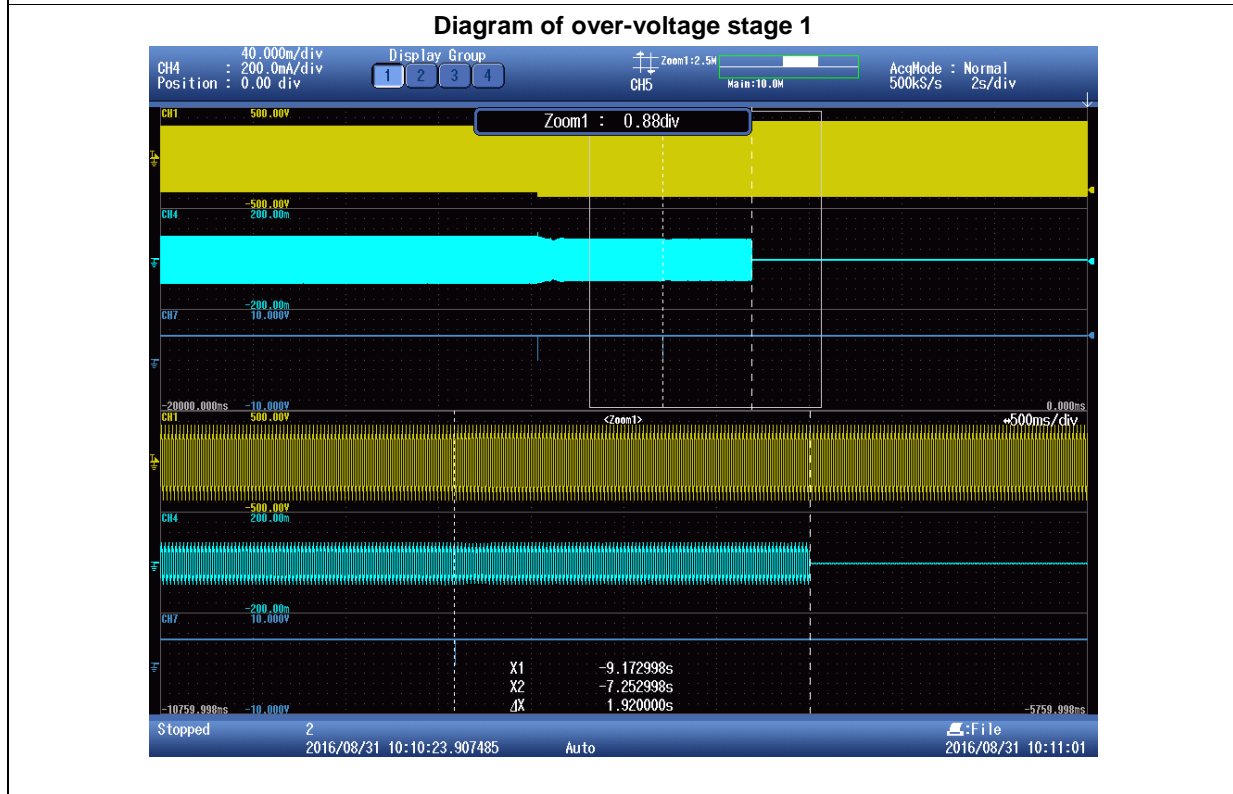
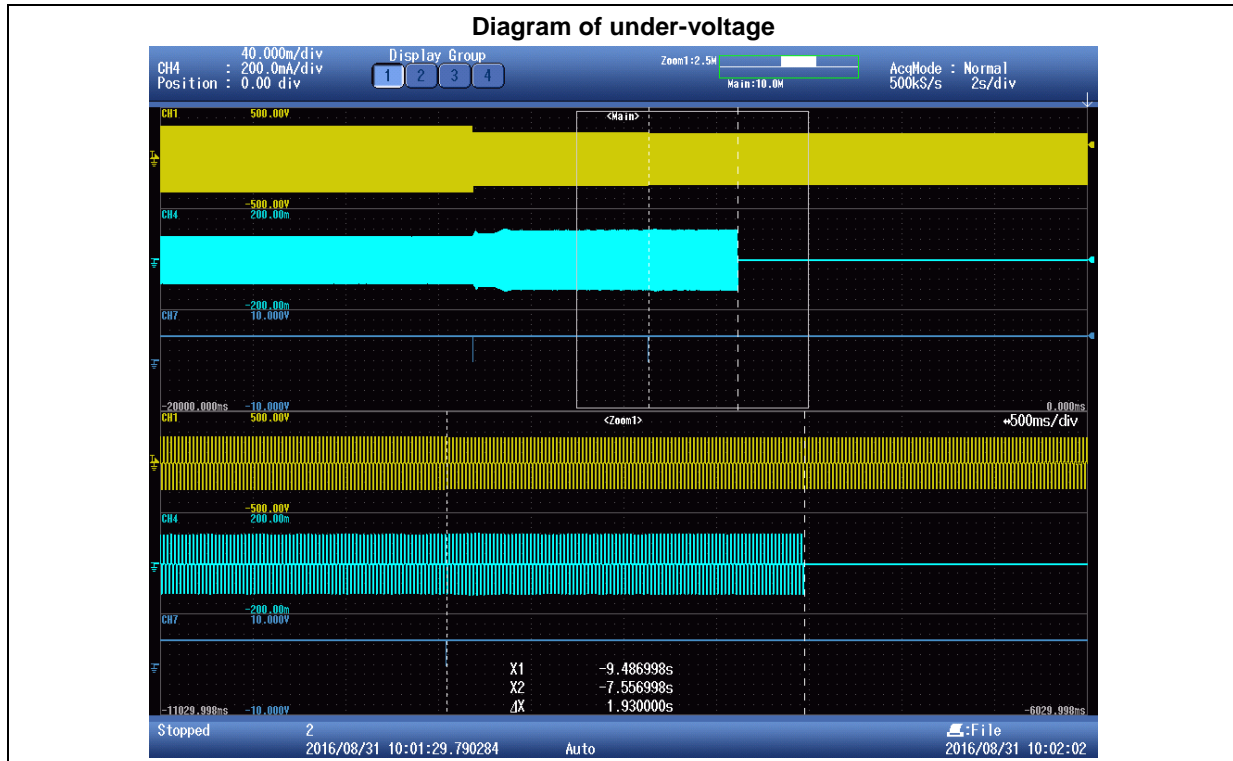

7.4 Voltage and frequency limits (passive anti-islanding protection) Appendix G3 Under- and over-frequency trip settings and reconnection test							P
Output Current level: 50+/-5% rated current or 10A (whichever is the lesser)							
Test	Under Frequency (Hz)			Time to disconnect (s) (Trip delay 1s)			Time to reconnect (s)
Australia Limit	≥47Hz			≤2s			≥60s
Actual setting	47,0			2,0			60,0
Trip value	47,00	47,00	47,00	1,720	1,620	1,630	64,0
Test	Under Frequency (Hz)			Time to disconnect (s) (Trip delay 1s)			Time to reconnect (s)
New Zealand Limit	≥45Hz			≤2s			≥60s
Actual setting	45,0			2,0			60,0
Trip value	44,99	44,99	44,99	1,715	1,620	1,620	79,0
Test	Over Frequency (Hz)			Time to disconnect (s)			Time to reconnect (s)
Limit	≤52Hz			≤0,2s			≥60s
Actual setting	52,0			0,2			60,0
Trip value	52,02	52,02	52,02	0,124	1,440	1,530	78,0
Note: Actual settings are the settings of the inverter. The trip value is the measured value. It has to be in the range of <u>+/- 0.1Hz</u> of the actual setting.							
The tests had been performed on the SOFAR 3000TL is valid for the SOFAR 1100TL, SOFAR 1600TL, SOFAR 2200TL, SOFAR 2700TL, since it is identical in hardware and just power derated by software.							

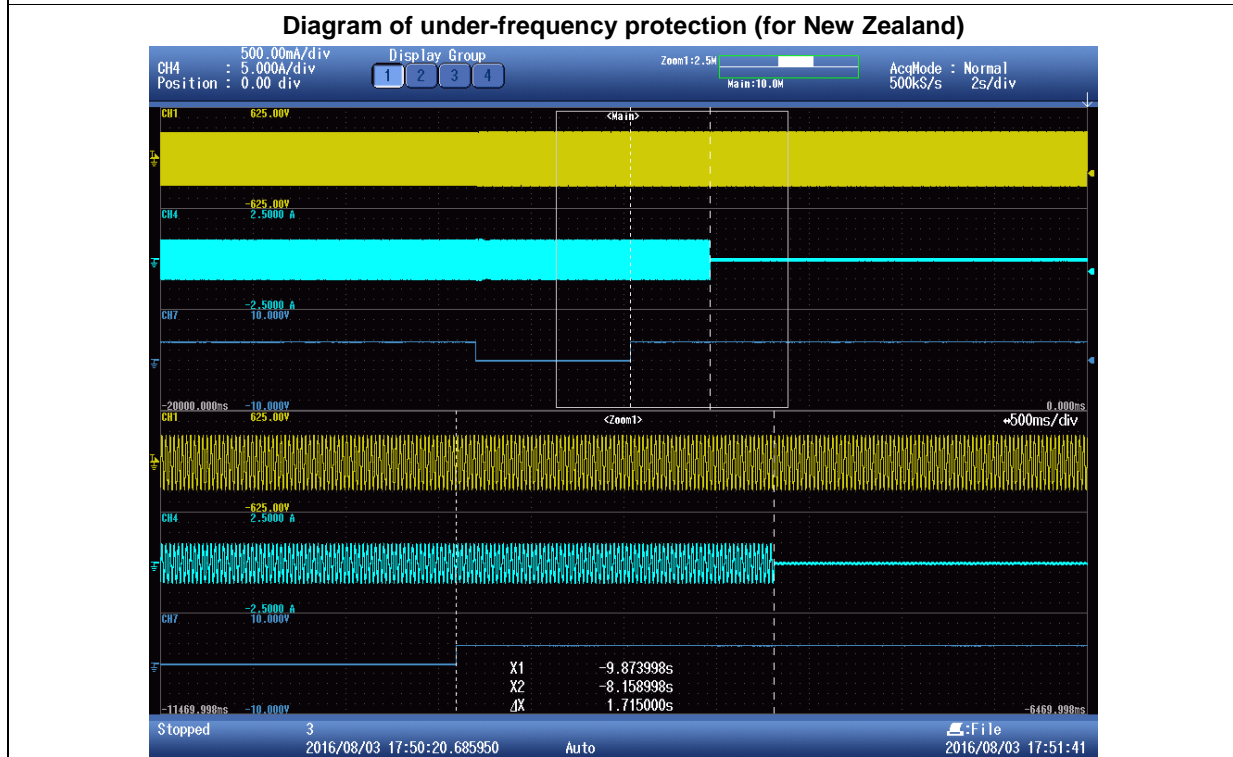
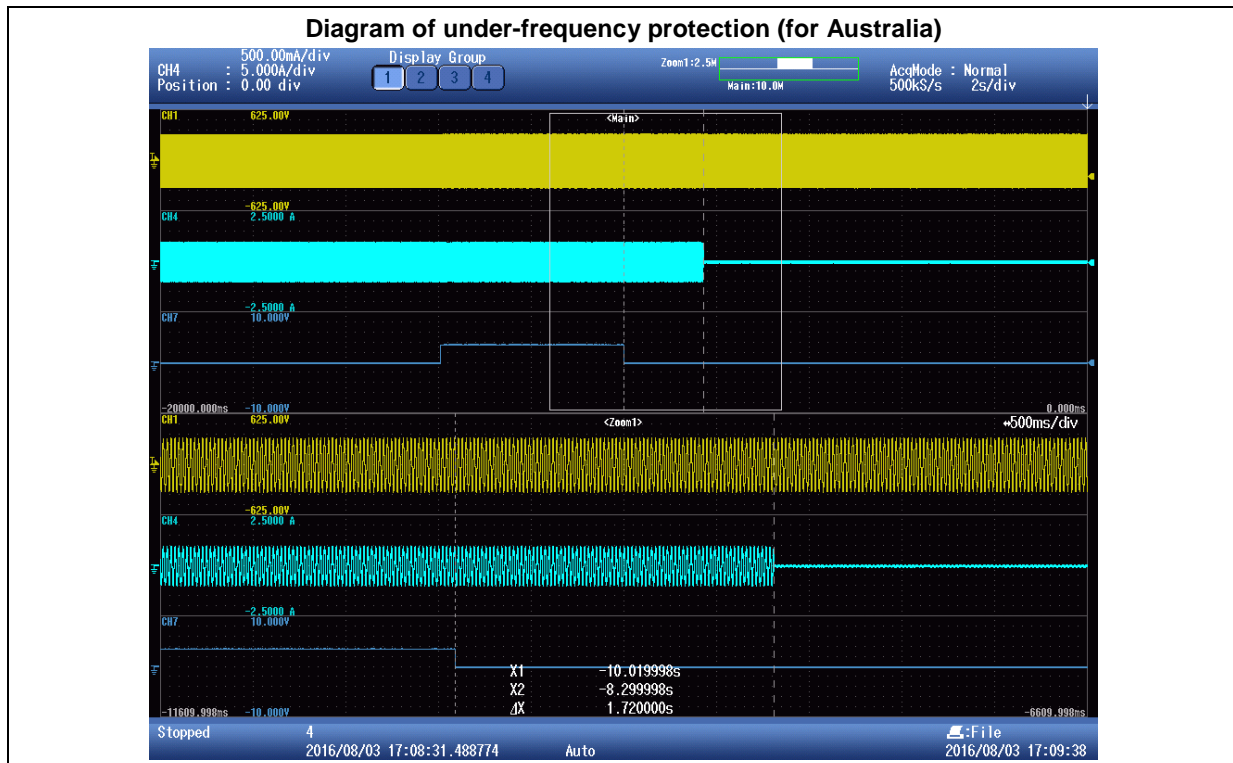

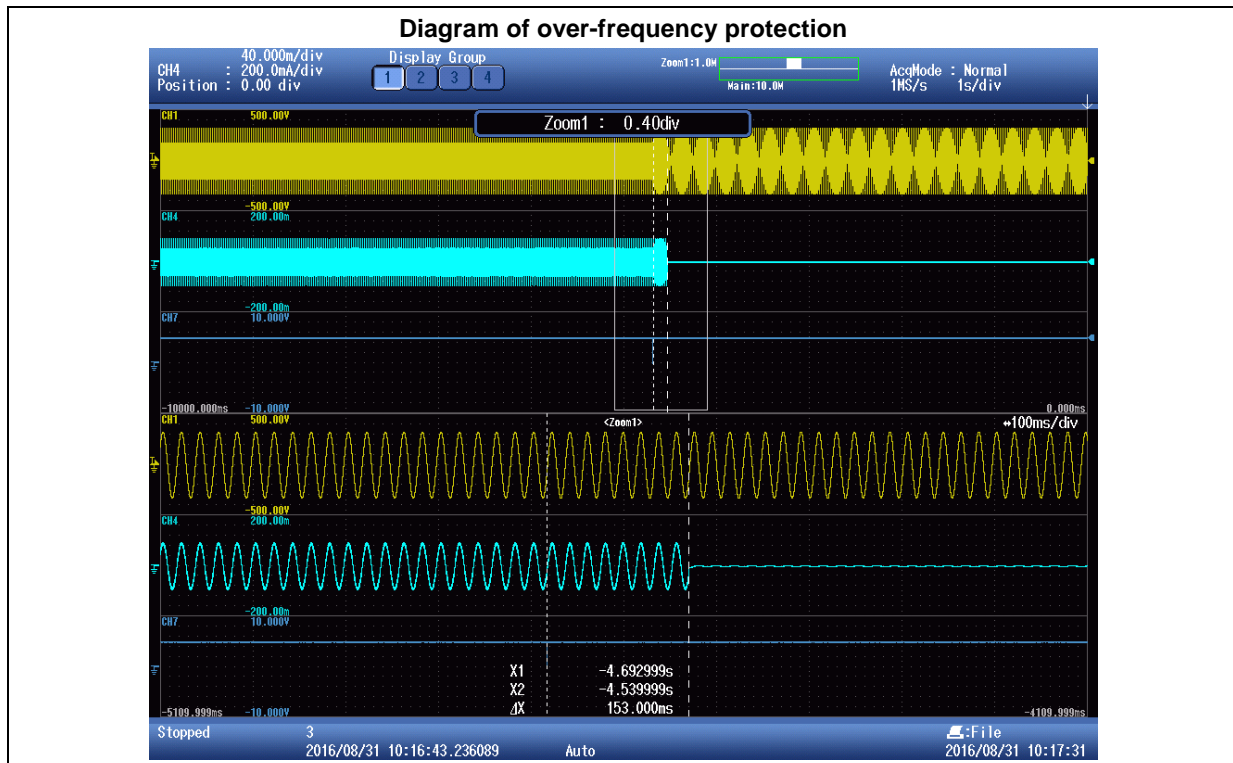

7.5.2 Limits for sustained operation Appendix H2 Sustained operation for voltage variations Australia			P	
Output power level: 50+/-5% Apparent Power				
Setting values	Setting V _{nom_max} [V]	255,0		
	Setting T _{disconnection} [s]	15,0		
Test:				
Step 1. The voltage is set to V _{nom_max} – 1 V. Maintained for 5 min. Step 2. The voltage increase to V _{nom_max} + 1 V and proceeding 10 min. Step 3. The 10 min average voltage shall be recorded.				
a)	Average Voltage (V)		Limit	
	Phase 1	1 st time	255,7	1. Disconnection should take place. 2. Voltage within +/1 % of the set-point.
		2 nd time	255,4	
		3 rd time	255,4	
	Phase 2	1 st time	Single phase	
		2 nd time	Single phase	
		3 rd time	Single phase	
	Phase 3	1 st time	Single phase	
		2 nd time	Single phase	
		3 rd time	Single phase	
Step 1. The voltage is set to V _{nom_max} and maintained for 10 min. Step 2. Increase 2 V to trig the protection. Step 3. Record the disconnection time.				
b)	Disconnection time (s)		Limit	
	Phase 1	11	Disconnection time < 30s	
	Phase 2	Single phase		
	Phase 3	Single phase		
Step 1. The output voltage of variable a.c. supply decrease the voltage to grid test voltage. Step 2. Record the reconnection time.				
c)	Reconnection time (s)		Limit	
	Phase 1	76	Reconnection time > 60s	
	Phase 2	Single phase		
	Phase 3	Single phase		
Note: 1. The default set-point for V _{nom-max} shall be as follows: (a) In Australia: 255 V. (b) In New Zealand: 248 V. 2. The 10 min average value shall be compared against the limit V _{nom_max} at least every 3 s to determine when to disconnect. 3. The inverter shall operate the automatic disconnection device (see Clause 7.2) within 3 s when the average voltage for a 10 min period exceeds the V _{nom_max} .				
The tests had been performed on the SOFAR 3000TL is valid for the SOFAR 1100TL, SOFAR 1600TL, SOFAR 2200TL, SOFAR 2700TL, since it is identical in hardware and just power derated by software.				

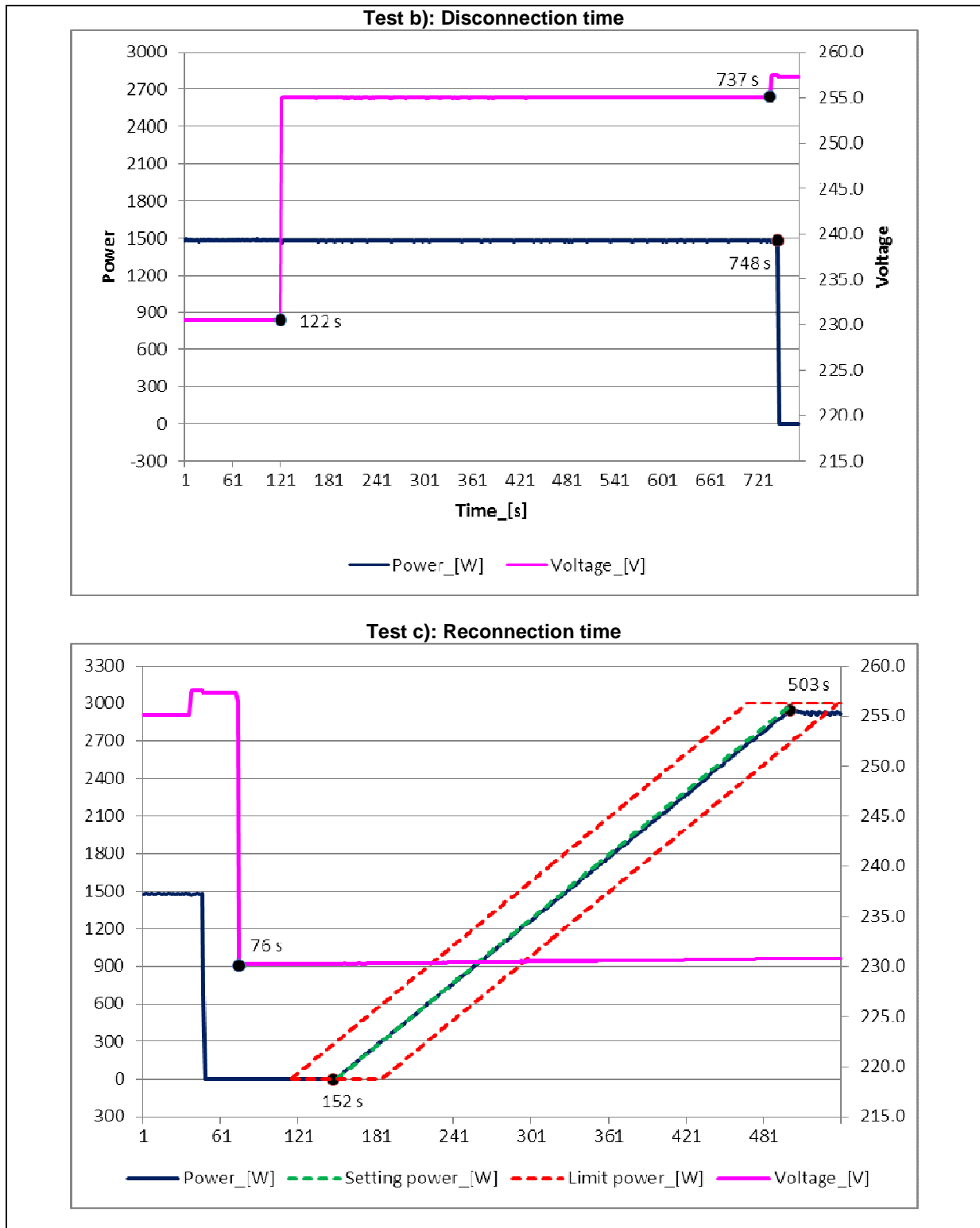

7.5.2 Limits for sustained operation Appendix H2 Sustained operation for voltage variations New Zealand			P	
Output power level: 50+/-5% Apparent Power				
Setting values	Setting V _{nom_max} [V]	248,0		
	Setting T _{disconnection} [s]	15,0		
Test:				
Step 1. The voltage is set to V _{nom_max} – 1 V. Maintained for 5 min. Step 2. The voltage increase to V _{nom_max} + 1 V and proceeding 10 min. Step 3. The 10 min average voltage shall be recorded.				
a)	Average Voltage (V)		Limit	
	Phase 1	1 st time	248,3	1. Disconnection should take place. 2. Voltage within +/1 % of the set-point.
		2 nd time	248,3	
		3 rd time	248,3	
	Phase 2	1 st time	Single phase	
		2 nd time	Single phase	
		3 rd time	Single phase	
	Phase 3	1 st time	Single phase	
		2 nd time	Single phase	
		3 rd time	Single phase	
Step 1. The voltage is set to V _{nom_max} and maintained for 10 min. Step 2. Increase 2 V to trig the protection. Step 3. Record the disconnection time.				
b)	Disconnection time (s)		Limit	
	Phase 1	11	Disconnection time < 30s	
	Phase 2	Single phase		
	Phase 3	Single phase		
Step 1. The output voltage of variable a.c. supply decrease the voltage to grid test voltage. Step 2. Record the reconnection time.				
c)	Reconnection time (s)		Limit	
	Phase 1	74	Reconnection time > 60s	
	Phase 2	Single phase		
	Phase 3	Single phase		
Note: 1. The default set-point for V _{nom-max} shall be as follows: (a) In Australia: 255 V. (b) In New Zealand: 248 V. 2. The 10 min average value shall be compared against the limit V _{nom_max} at least every 3 s to determine when to disconnect. 3. The inverter shall operate the automatic disconnection device (see Clause 7.2) within 3 s when the average voltage for a 10 min period exceeds the V _{nom_max} .				
The tests had been performed on the SOFAR 3000TL is valid for the SOFAR 1100TL, SOFAR 1600TL, SOFAR 2200TL, SOFAR 2700TL, since it is identical in hardware and just power derated by software.				

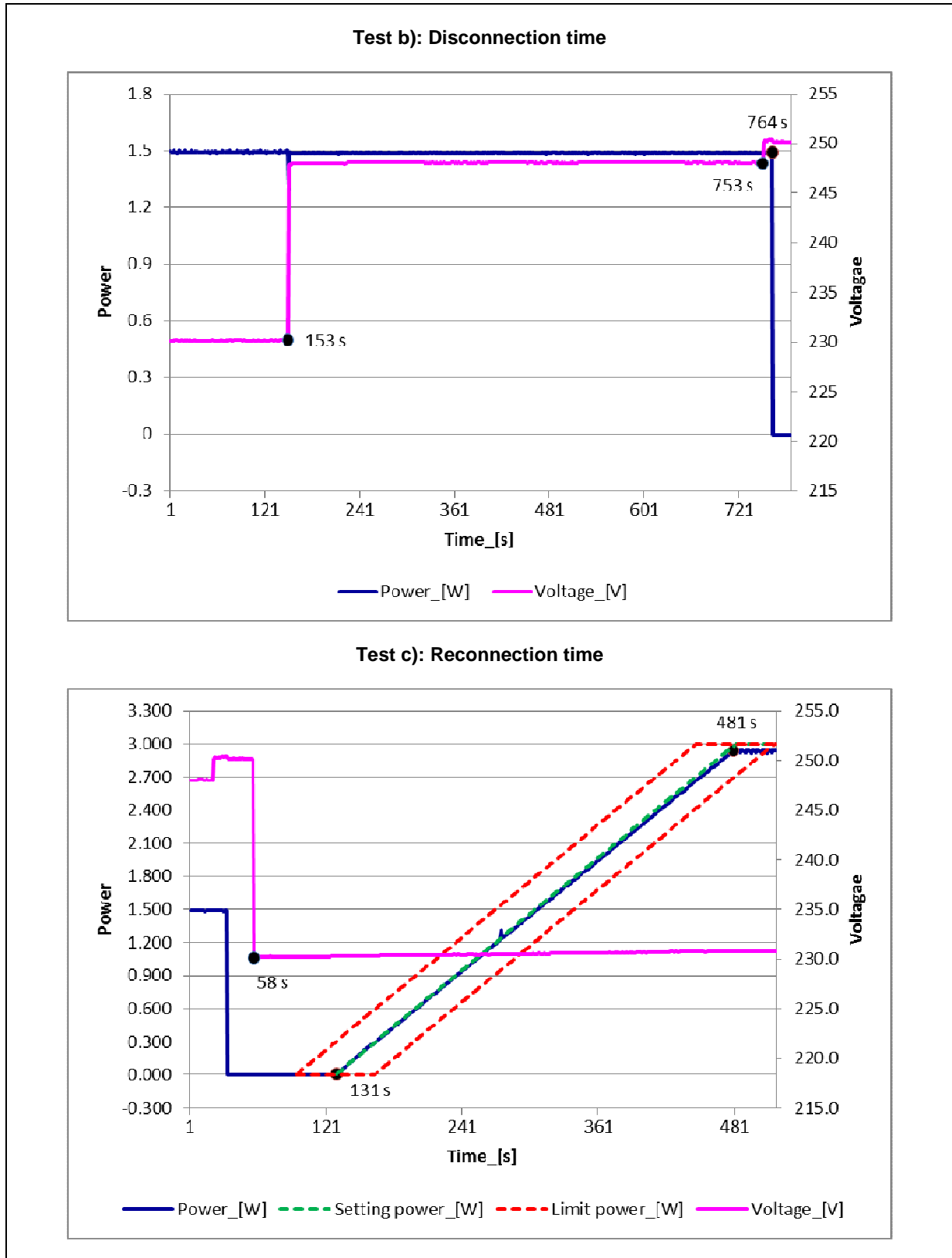

7.5.3.1 Response to an increase in frequency Appendix H3.2 Test procedure							P
1. Measurement a) to w): Power output: 50+/-5% of rated apparent power							
30s mean value	a) 50,00Hz	b) 50,25Hz	c) 50,35Hz	d) 50,45Hz	e) 50,55Hz	f) 50,65Hz	g) 50,75Hz
Frequency [Hz]:	50.00	50.25	50.35	50.45	50.55	50.65	50.75
P _{setpoint} [kW]:	1.500	1.500	1.414	1.329	1.243	1.157	1.071
P [kW]:	1.500	1.500	1.420	1.320	1.230	1.140	1.060
$\Delta P/P_{Setpoint}$ [%]:	0.00	0.00	0.19	-0.29	-0.43	-0.57	-0.38
30s mean value	h) 50,85Hz	i) 50,95Hz	j) 51,05Hz	k) 51,15Hz	l) 51,25Hz	m) 51,35Hz	n) 51,45Hz
Frequency [Hz]:	50.85	50.95	51.05	51.15	51.25	51.35	51.45
P _{setpoint} [kW]:	0.986	0.900	0.814	0.729	0.643	0.557	0.471
P [kW]:	0.970	0.890	0.800	0.720	0.630	0.550	0.460
$\Delta P/P_{Setpoint}$ [%]:	-0.52	-0.33	-0.48	-0.29	-0.43	-0.24	-0.38
30s mean value	o) 51,55Hz	p) 51,65Hz	q) 51,75Hz	r) 51,85Hz	s) 51,95Hz	t) 52,05Hz	u) 52,15Hz
Frequency [Hz]:	51.55	51.65	51.75	51.85	51.95	52.05	52.15
P _{setpoint} [kW]:	0.386	0.300	0.214	0.129	0.043	0.000	0.000
P [kW]:	0.370	0.290	0.210	0.120	0.030	0.030	0.030
$\Delta P/P_{Setpoint}$ [%]:	-0.52	-0.33	-0.14	-0.29	-0.43	1.00	1.00
<p><i>The frequency shall be decreased every 30 s in 0.2 Hz decrements from 52,25Hz until less than 50,15Hz. Maintained for 10 min or until the inverter reaches the maximum output power available. After frequency decreased to less than 50,15Hz, adjust output power to 100% rated power.</i></p>							
30s mean value	v) 52,25Hz	->	w) 50,05Hz	-	-	-	-
Frequency [Hz]:	52.25	-	50.05	-	-	-	-
P _{setpoint} [kW]:	0.000	-	0.000	-	-	-	-
P [kW]:	0.030	-	0.010	-	-	-	-
$\Delta P/P_{Setpoint}$ [%]:	1.00	-	0.33	-	-	-	-
Limit W_{Gra}:	+ 17,0%						
Note:							
<p>1. The output power at grid test voltage/50,00Hz shall be maintained for 5 min and the average power shall be used as the frozen value of power (Pref)</p> <p>2. The frequency increase rate: 0.1Hz/step/30s.</p> <p>3. The frequency decrease rate: 0.2Hz/step/30s.</p> <p>4. While the frequency decrease less than 50,15Hz, the voltage and frequency shall be maintained for 10 min or until the inverter reaches the maximum output power available.</p> <p>5 After frequency decrease less than 50,15Hz, adjust output power to 100% rated power.</p>							
<p>The tests had been performed on the SOFAR 3000TL is valid for the SOFAR 1100TL, SOFAR 1600TL, SOFAR 2200TL, SOFAR 2700TL, since it is identical in hardware and just power derated by software.</p>							

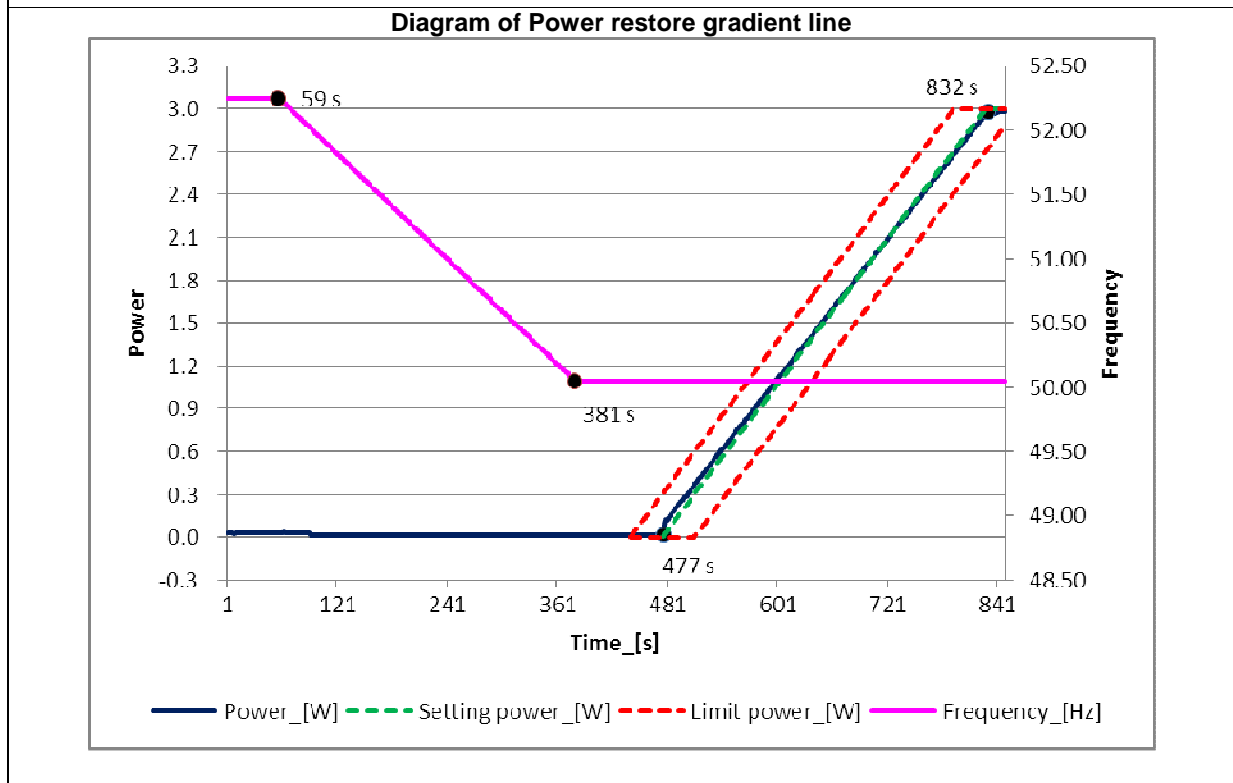
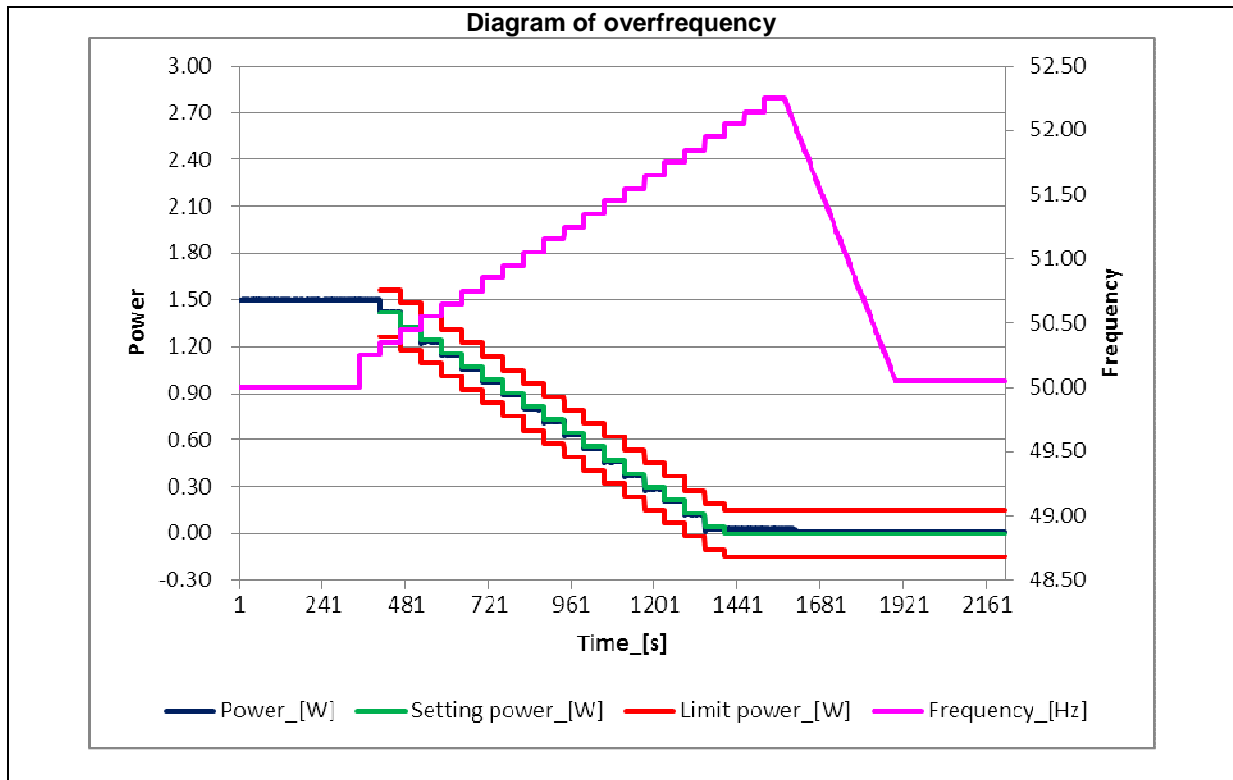

7.5.3.1 Response to an increase in frequency (continued) Appendix H3.2 Test procedure (continued)							P
2. Measurement a) to o): Power output: 50+/-5% of rated apparent power							
30s mean value	a) 50,00Hz	b) 50,25Hz	c) 50,35Hz	d) 50,45Hz	e) 50,55Hz	f) 50,65Hz	g) 50,75Hz
Frequency [Hz]:	50.00	50.25	50.35	50.45	50.55	50.65	50.75
P _{setpoint} [kW]:	1.500	1.500	1.399	1.314	1.229	1.145	1.060
P [kW]:	1.483	1.484	1.406	1.298	1.216	1.131	1.047
$\Delta P/P_{Setpoint}$ [%]:	-0.562	-0.546	0.228	-0.530	-0.444	-0.439	-0.423
30s mean value	h) 50,85Hz	i) 50,95Hz	j) 51,05Hz				
Frequency [Hz]:	50.85	50.95	51.05	-	-	-	-
P _{setpoint} [kW]:	0.975	0.890	0.805	-	-	-	-
P [kW]:	0.96	0.88	0.79	-	-	-	-
$\Delta P/P_{Setpoint}$ [%]:	-0.420	-0.397	-0.349	-	-	-	-
<i>The frequency shall be decreased every 30 s in 0.2 Hz decrements from 51,05Hz until less than 50,15Hz. Maintained for 10 min or until the inverter reaches the maximum output power available. After frequency decreased to less than 50,15Hz, adjust output power to 100% rated power.</i>							
30s mean value	k) 50,85Hz	l) 50,65Hz	m) 50,45Hz	n) 50,25Hz	o) 50,05Hz	-	-
Frequency [Hz]:	50.85	50.65	50.45	50.25	50.05	-	-
P _{setpoint} [kW]:	0.805	0.805	0.805	0.805	0.805	-	-
P [kW]:	0.795	0.795	0.795	0.795	0.797	-	-
$\Delta P/P_{Setpoint}$ [%]:	-0.347	-0.356	-0.352	-0.347	-0.289	-	-
Limit W _{Gra} :	+ 17,0%						
Note:							
1. The output power at grid test voltage/50,00Hz shall be maintained for 5 min and the average power shall be used as the frozen value of power (Pref)							
2. The frequency increase rate: 0.1Hz/step/30s.							
3. The frequency decrease rate: 0.2Hz/step/30s.							
4. While the frequency decrease less than 50,15Hz, the voltage and frequency shall be maintained for 10 min or until the inverter reaches the maximum output power available.							
5. After frequency decrease less than 50,15Hz, adjust output power to 100% rated power.							
The tests had been performed on the SOFAR 3000TL is valid for the SOFAR 1100TL, SOFAR 1600TL, SOFAR 2200TL, SOFAR 2700TL, since it is identical in hardware and just power derated by software.							

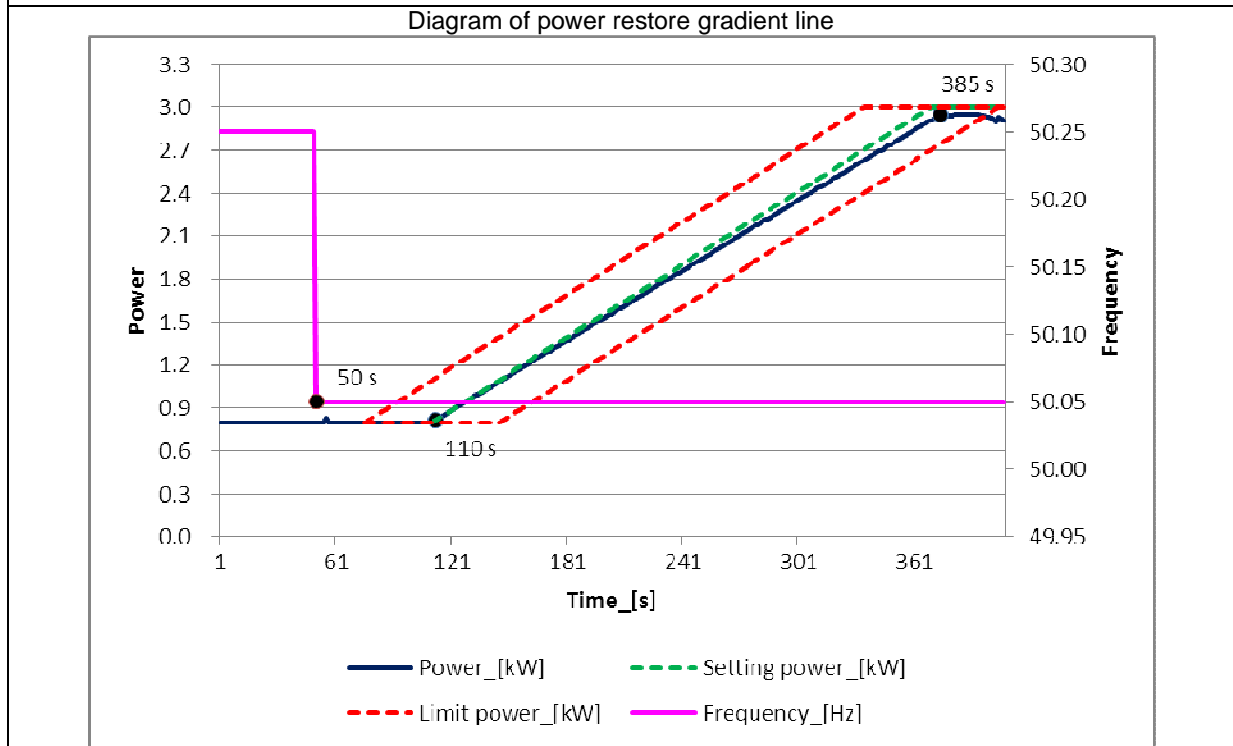
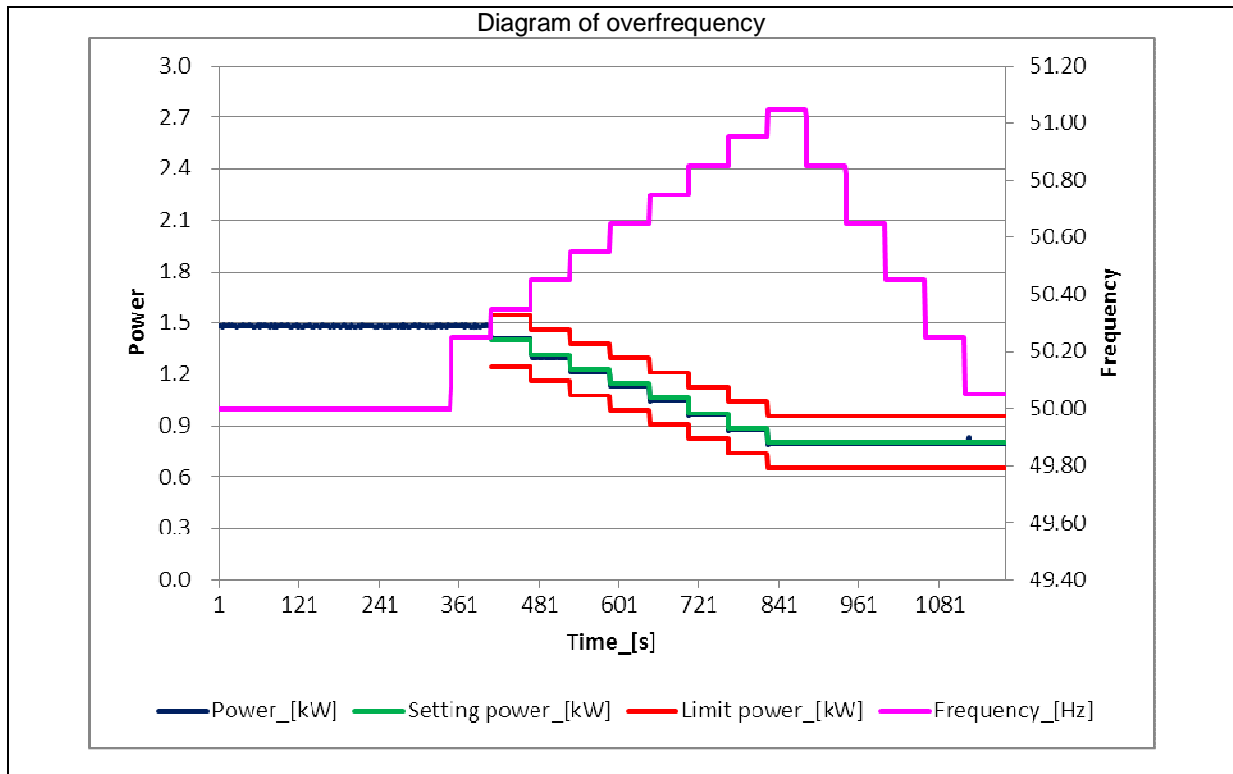



Report No.: PVAU160721N056-1-R2

Annex 1

EMC Test Report



STC (Dongguan) Company Limited
CERTIFICATE OF COMPLIANCE

Reference Number: EMC-D162995COC

APPLICANT:

Shenzhen SOFARSOLAR Co., Ltd.
3A-1, Huake Building, East Technology Park, Qiaoxiang Road, Nanshan District, Shenzhen,
China.

DESCRIPTION OF SAMPLE:

Product: PV Inverter
Manufacturer: Shenzhen SOFARSOLAR Co., Ltd.
3A-1, Huake Building, East Technology Park, Qiaoxiang Road,
Nanshan District, Shenzhen, China.
Model No.: SOFAR 3000TL
Additional Model No.: SOFAR 1100TL, SOFAR 1800TL, SOFAR 2200TL, SOFAR 2700TL
Brand Name: SOFAR
Origin: China

Applicable Standard(s) with amendments:

EN61000-6-3: 2007 +A1: 2011, EN61000-6-2: 2005
EN61000-3-2: 2014, EN61000-3-3: 2013

REFERENCE TEST REPORT NUMBER: DM122441.

This Certificate shall be used in conjunction with the above mentioned test report.

*This is to certify that the submitted sample has been tested in
accordance with and found to be in compliance with the said
investigation.*

Date: 2016-02-01



LONG Yun Jian
Authorized Signatory
ElectroMagnetic Compatibility Department
For and on behalf of
STC (Dongguan) Company Limited

www.dgstc.org



STC Test Report



Date: 2016-02-01
No.: DMI22441

Page 1 of 40

Applicant: Shenzhen SOFARSOLAR Co., Ltd.
3A-1, Huake Building, East Technology Park, Qiaoxiang
Road, Nanshan District, Shenzhen, China.

Description of Sample(s): Submitted sample(s) said to be
Product: PV Inverter
Brand Name: SOFAR
Model Number: SOFAR 3000TL
Additional Model Number(s): SOFAR 1100TL, SOFAR 1600TL,
SOFAR 2200TL, SOFAR 2700TL

Date Sample(s) Received: 2015-11-27

Date Tested: 2015-12-01 to 2016-01-30

Investigation Requested: Test for compliance with EMC requirements of
EN61000-6-3, EN61000-6-2, EN61000-3-2, EN61000-3-3.

Conclusion(s): The submitted product **COMPLIED** with the requirements
of EN61000-6-3: 2007 +A1: 2011, EN61000-6-2: 2005,
EN61000-3-2: 2014, EN61000-3-3: 2013. The EMC tests were
performed in accordance with the standards described above
and on Section 2.2 in this Test Report.

Remark(s): Deutsche Akkreditierungsstelle GmbH (DAkkS) has
accredited this laboratory for specific laboratory activities as
listed in the directory of accredited laboratories
(D-PL-12121-01-00)



LONG Yun
Authorized Signatory
ElectroMagnetic Compatibility Department
For and on behalf of
STC (Dongguan) Company Limited

STC (Dongguan) Company Limited

88 Fumin Nan Road, Daling, Dongguan, China. (Zip Code: 523 770)
Tel: (86 769) 8111 9066 Fax: (86 769) 8111 8223 E-mail: dgstc@dgstc.org Homepage: www.dgstc.org
This report shall not be reproduced unless with prior written approval from STC (Dongguan) Company Limited.
For Conditions of Issuance of this test report, please refer to the overleaf or Homepage.



STC Test Report

Date: 2016-02-01
No.: DMI22441

Page 2 of 40

CONTENT:

Cover	Page 1 of 40
Content	Page 2 of 40
1.0 General Detail:	
1.1 Equipment Under Test [EUT] Description of Sample(s)	Page 4 of 40
1.2 Date of Order	Page 4 of 40
1.3 Submitted Sample(s)	Page 4 of 40
1.4 Test Duration	Page 4 of 40
1.5 Country of Origin	Page 4 of 40
2.0 Technical Details:	
2.1 Investigations Requested	Page 5 of 40
2.2 Test Standards and Results Summary	Page 5-6 of 40
3.0 Test Results:	
3.1 Emission	Page 7-21 of 40
3.2 Immunity	Page 22-40 of 40
Appendix A	
List of Measurement Equipment	Page A1-A3 of A3
Appendix B	
Photograph(s) of Product	Page B1-B9 of B9

STC (Dongguan) Company Limited

88 Fuzhi Nan Road, Daxing, Dongguan, China. (Zip Code: 523 770)
Tel: (86 769) 8111 9666 Fax: (86 769) 8111 0322 E-mail: dgstc@dgstc.org Homepage: www.dgstc.org
This report shall not be reproduced unless with prior written approval from STC (Dongguan) Company Limited.
For Conditions of issuance of this test report, please refer to the overleaf or Homepage.



STC Test Report

Date: 2016-02-01
No.: DM122441

Page 3 of 40

1.0 General Details

1.1 Equipment Under Test [EUT] Description of Sample(s)

Product: PV Inverter
 Manufacturer: Shenzhen SOFARSOLAR Co., Ltd.
 3A-1, Huake Building, East Technology Park, Qiaoxiang Road,
 Nanshan District, Shenzhen, China.
 Brand Name: SOFAR
 Model Number: SOFAR 3000TL
 Additional Model Number(s): SOFAR 1100TL, SOFAR 1600TL, SOFAR 2200TL,
 SOFAR 2700TL
 Rating:

Model	SOFAR 1100TL	SOFAR 1600TL	SOFAR 2200TL	SOFAR 2700TL	SOFAR 3000TL
Output data (Grid)					
Maximum AC output	1000VA	1550VA	2100VA	2600VA	3000VA
Maximum AC output current	4.5A	7A	9.5A	11.5A	13A
Nominal AC voltage	230V				
Grid AC frequency	50HZ				
Power factor	1				
Reactive power factor	+/-0.8				
Total harmonic distortion	<3%				
AC connection/grid forms	Single phase				
Input data (solar)					
Maximum DC power	1100W	1600W	2200W	2700W	3000W
Maximum DC input current	10A	10A	13A	13.5A	15A
Max.number of MPP trackers	1	1	1	1	1
Maximum DC voltage	450V	450V	500V	500V	500V
Operating voltage range	80-450V	80-450V	100-500V	100-500V	100-500V
MPP tracking voltage range	80-450V	80-450V	100-500V	100-500V	100-500V
Peak power tracking voltage range	110-450V	165-450V	170-500V	200-500V	200-500V

STC (Dongguan) Company Limited

88 Fushin Nan Road, Daling, Dongguan, China. (Zip Code: 523370)
 Tel: (86 769) 8111 9888 Fax: (86 769) 8111 0222 E-mail: dgstc@dgstc.org Homepage: www.dgstc.org
 This report shall not be reproduced unless with prior written approval from STC (Dongguan) Company Limited.
 For Conditions of Issuance of this test report, please refer to the coverleaf or Homepage.



STC Test Report

Date: 2016-02-01
No.: DMI22441

Page 4 of 40

1.2 Date of Order

2015-11-27

1.3 Submitted Sample(s):

1 Sample

1.4 Test Duration

2015-12-01 to 2016-01-30

1.5 Country of Origin

China

STC (Dongguan) Company Limited

88 Famin Nan Road, Daling, Dongguan, China. (Zip Code: 523 770)
Tel.: (86 769) 8111 9666 Fax: (86 769) 8111 0323 E-mail: dgstc@dgstc.org Homepage: www.dgstc.org
This report shall not be reproduced unless with prior written approval from STC (Dongguan) Company Limited.
For Conditions of Issuance of this test report, please refer to the overleaf or Homepage.



STC Test Report

Date: 2016-02-01
No.: DMI22441

Page 5 of 40

2.0 Technical Details

2.1 Investigations Requested

Perform ElectroMagnetic Interference [EMI] & ElectroMagnetic Susceptibility [EMS] tests for CE Marking

2.2 Test Standards and Results Summary Tables

Test Standards	
EN61000-6-3: 2007 +A1:2011	Electromagnetic compatibility (EMC) - Part 6-3: Generic standards - Emission standard for residential, commercial and light-industrial environments
EN61000-6-2: 2005	Electro-magnetic compatibility (EMC) - Part 6-2: Generic standards - Immunity for industrial environments
EN61000-3-2: 2014	Electromagnetic compatibility (EMC) - Part 3-2: Limits - Limits for harmonic current emissions (equipment input current \leq 16 A per phase)
EN61000-3-3: 2013	Electromagnetic compatibility (EMC) - Part 3-3: Limits - Limitation of voltage changes, voltage fluctuations and flicker in public low-voltage supply systems, for equipment with rated current \leq 16 A per phase and not subject to conditional connection

STC (Dongguan) Company Limited

88 Fushan Nan Road, Daling, Dongguan, China. (Zip Code: 523770)
Tel: (+86 769) 8111 9666 Fax: (+86 769) 8111 0222 E-mail: dgstc@dgstc.org Homepage: www.dgstc.org
This report shall not be reproduced unless with prior written approval from STC (Dongguan) Company Limited.
For Conditions of Issuance of this test report, please refer to the coverleaf or homepage.



STC Test Report

Date: 2016-02-01
No.: DMI22441

Page 6 of 40

2.2 Test Standards and Results Summary Tables

EMISSION (EN 61000-6-3:2007+A1:2011) Results Summary					
Test Condition	Test Requirement	Limits	Test Result		
			Pass	Failed	N/A
Radiated Emission, 30MHz to 1000MHz	EN61000-6-3: 2007+ A1:2011	Table 1	<input checked="" type="checkbox"/>	<input type="checkbox"/>	<input type="checkbox"/>
Conducted Emission on at main terminal 150kHz to 30MHz	EN61000-6-3: 2007+ A1:2011	Table 1	<input checked="" type="checkbox"/>	<input type="checkbox"/>	<input type="checkbox"/>
Harmonic current emissions	EN61000-3-2: 2014	Class A	<input checked="" type="checkbox"/>	<input type="checkbox"/>	<input type="checkbox"/>
Voltage fluctuations & Flicker	EN61000-3-3: 2013	Ps=1 dc(%)=3.3% dMax.(%)=4% d(t)=3.3%=500ms	<input checked="" type="checkbox"/>	<input type="checkbox"/>	<input type="checkbox"/>

IMMUNITY (EN 61000-6-2:2005) Results Summary					
Test Condition	Test Requirement	Performance Criteria	Test Result		
			Pass	Failed	N/A
Electrostatic Discharge	IEC 61000-4-2:2008	B	<input checked="" type="checkbox"/>	<input type="checkbox"/>	<input type="checkbox"/>
Radiated Immunity 80MHz to 2700MHz	IEC 61000-4-3:2008	A	<input checked="" type="checkbox"/>	<input type="checkbox"/>	<input type="checkbox"/>
Electrical Fast Transients	IEC 61000-4-4:2004 +Corr.1:2006+Corr.2:2007	B	<input checked="" type="checkbox"/>	<input type="checkbox"/>	<input type="checkbox"/>
Surge Immunity	IEC 61000-4-5:2005	B	<input checked="" type="checkbox"/>	<input type="checkbox"/>	<input type="checkbox"/>
Continuous RF Immunity	IEC 61000-4-6:2008	A	<input checked="" type="checkbox"/>	<input type="checkbox"/>	<input type="checkbox"/>
Power frequency magnetic field	IEC 61000-4-8:2009	A	<input checked="" type="checkbox"/>	<input type="checkbox"/>	<input type="checkbox"/>
Common Mode Disturbance	IEC 61000-4-16:1998+A1:2001 +A2:2009	A	<input checked="" type="checkbox"/>	<input type="checkbox"/>	<input type="checkbox"/>
Oscillatory Waves	IEC 61000-4-18:2011	B	<input checked="" type="checkbox"/>	<input type="checkbox"/>	<input type="checkbox"/>
DC Voltage Dips and Interruptions	IEC 61000-4-29:2000	B	<input checked="" type="checkbox"/>	<input type="checkbox"/>	<input type="checkbox"/>

Note: The performance criteria for immunity test is referring to the standard of CEI 0-21:2012.
The scope of DAkkS accreditation not indicates the standard of
IEC 61000-4-16:1998+A1:2001 +A2:2009, IEC 61000-4-18:2011, IEC 61000-4-29:2000.

Remarks:
N/A: Not Applicable
U_T: The nominal supply voltage

STC (Dongguan) Company Limited

88 Fushan Nan Road, Daling, Dongguan, China. ZIP Code: 523 770
Tel: (86 769) 8111 8066 Fax: (86 769) 8111 8222 E-mail: dgstc@dgstc.org Homepage: www.dgstc.org
This report shall not be reproduced unless with prior written approval from STC (Dongguan) Company Limited.
For Conditions of Issuance of this test report, please refer to the booklet or Homepage.



STC Test Report

Date: 2016-02-01
No.: DMI22441

Page 7 of 40

3.0 Test Results

3.1 Emission

3.1.1 Radiated Emissions (30MHz to 1000MHz)

Test Requirement: EN 61000-5-3
Test Method: EN 55022
Level: Table 1

Mode of Operation: Full load mode

Test Method:

The test was performed in accordance with EN 55022 at 10m test distance on a standard emission test site, with quasi-peak measurements performed if the maximised peak measurements were less than 6dB from the corresponding Class B limit lines.

Test Procedure:

The EUT is a PV Inverter, the test was conducted during the full load test function to simulate the normal usage as well as to produce the maximum electromagnetic disturbances.

Test Setup:

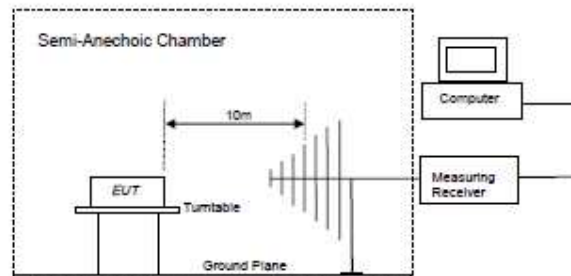

STC (Dongguan) Company Limited

88 Fanchi Nan Road, Daxing, Dongguan, China. (Zip Code: 523 770)
Tel: (86 769) 8111 9656 Fax: (86 769) 8111 0222 E-mail: dgstc@dgstc.org Homepage: www.dgstc.org
This report shall not be reproduced unless with prior written approval from STC (Dongguan) Company Limited.
For Conditions of Issuance of this test report, please refer to the overleaf or Homepage.



STC Test Report

Date: 2016-02-01
No.: DMI22441

Page 8 of 40

Limits for Radiated Emission:

Frequency Range [MHz]	Quasi-Peak Limits [dB μ V/m]
30-230	30.0
230-1000	37.0

Results of Full load mode: Pass

Please refer to the following table for result details

Horizontal

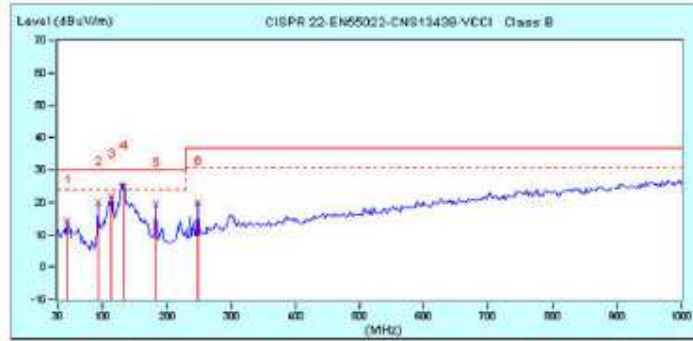

The quasi-peak measurements were recorded as follows:

No.	Frequency MHz	Factor dB/m	Reading dB μ V	Emission dB μ V/m	Limit dB μ V/m	Margin dB	Tower / Table cm / deg
1	43.66	14.99	-0.74	14.22	30.00	-15.78	143 / 0
2	92.08	10.26	0.47	10.73	30.00	-19.27	400 / 0
3	113.42	12.35	8.75	22.10	30.00	-7.90	400 / 0
4	130.88	13.29	11.50	24.79	30.00	-5.24	400 / 0
5	183.26	12.88	6.50	19.47	30.00	-10.53	210 / 0
6	247.28	14.09	5.71	19.80	37.00	-17.20	100 / 0

STC (Dongguan) Company Limited

88 Famin Han Road, Daxing, Dongguan, China. (Zip Code: 523 770)
Tel: (86 769) 8111 9668 Fax: (86 769) 8111 0332 E-mail: dgstc@dgstc.org Homepage: www.dgstc.org
This report shall not be reproduced unless with prior written approval from STC (Dongguan) Company Limited.
For Conditions of Issuance of this test report, please refer to the overleaf or Homepage.



STC Test Report

Date: 2016-02-01
No.: DM122441

Page 9 of 40

Limits for Radiated Emission:

Frequency Range [MHz]	Quasi-Peak Limits [dB μ V/m]
30-230	30.0
230-1000	37.0

Results of Full load mode: Pass

Please refer to the following table for result details

Vertical

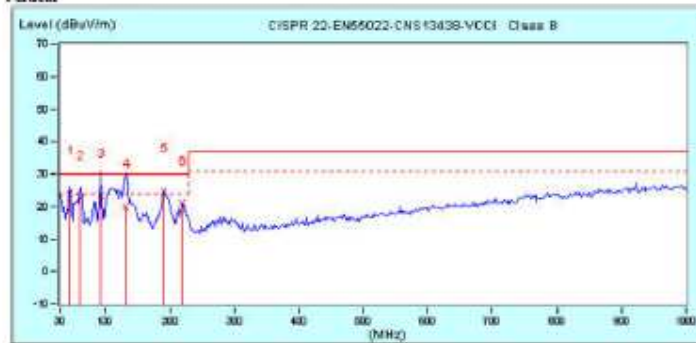

The quasi-peak measurements were recorded as follows:

No.	Frequency MHz	Factor dB/m	Reading dBuV	Emission dBuV/m	Limit dBuV/m	Margin dB	Tower / Table cm	deg
1	45.55	14.95	9.04	24.00	30.00	-6.00	195	120
2	61.04	13.29	9.31	22.89	30.00	-7.41	185	104
3	84.00	10.50	12.90	23.40	30.00	-6.60	100	20
4	130.00	13.28	9.94	23.10	30.00	-6.90	100	20
5	191.02	12.37	12.55	24.92	30.00	-5.08	120	72
6	220.12	12.84	8.38	21.02	30.00	-8.98	231	160

Remarks:

Calculated measurement uncertainty (30MHz – 1GHz): 4.6dB

Emissions in the vertical and horizontal polarizations have been investigated and the worst-case test results are recorded in this report.

STC (Dongguan) Company Limited

88 Fulin Nan Road, Daxing, Dongguan, China. (Zip Code: 523 770)
Tel: (86 769) 8111 9668 Fax: (86 769) 8111 6223 E-mail: dgstc@dgstc.org Homepage: www.dgstc.org
This report shall not be reproduced unless with prior written approval from STC (Dongguan) Company Limited.
For Conditions of Issuance of this test report, please refer to the coverleaf or Homepage.



STC Test Report

Date: 2016-02-01
No.: DMI22441

Page 10 of 40

3.1.2 Conducted Emission on at main terminal (150kHz to 30MHz)

Test Requirement: EN 61000-6-3
Test Method: EN 55022
Level: Table 1

Mode of Operation: Full load mode

Test Method:

Initial measurements were performed in peak and average detection modes on the live line. Any emissions recorded within 30dB of the relevant limit lines were re-measured using quasi-peak and average detection on the live and neutral lines with the worst case recorded in the table of results. The test was performed in accordance with EN 55022.

Test Procedure:

The EUT is a PV Inverter, the test was conducted during the full load test function to simulate the normal usage as well as to produce the maximum electromagnetic disturbances.

Test Setup:

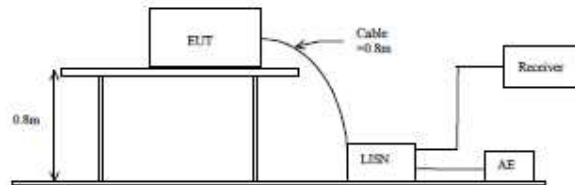

STC (Dongguan) Company Limited

88 Fuzhi Nan Road, Daxing, Dongguan, China. (Zip Code: 523 770)
Tel: (86 769) 8111 9666 Fax: (86 769) 8111 0222 E-mail: dgstc@dgstc.org Homepage: www.dgstc.org
This report shall not be reproduced unless with prior written approval from STC (Dongguan) Company Limited.
For Conditions of issuance of this test report, please refer to the coverleaf or Homepage.



STC Test Report

Date: 2016-02-01
No.: DMI22441

Page 11 of 40

Results and limit lines for Conducted Emission:
Limits for Conducted Emission Test, please refer to limit lines (Quasi-Peak and Average) in the following diagram.

Results of Full load mode (DC 230V) (L): Pass
Please refer to the following diagram for individual results.



No.	Frequency		Corr. Factor	Reading		Emission		Limit		Margin		Notes
	kHz	MHz		QP	AV	QP	AV	QP	AV	QP	AV	
1	0.16172	0.20	47.82	44.32	52.12	49.52	56.38	55.38	-12.25	-6.85		
2	0.28028	0.12	41.00	37.29	50.12	46.41	51.23	51.33	-11.20	-4.91		
3	0.30234	0.20	35.87	35.65	48.77	44.85	50.18	50.18	-11.41	-5.32		
4	0.38458	0.25	35.00	35.62	47.35	45.05	50.18	48.18	-10.82	-3.15		
5	0.49813	0.55	35.80	31.55	46.35	43.11	56.27	45.27	-10.02	-3.25		
6	4.20172	10.21	32.09	25.87	42.00	35.88	50.00	40.00	-18.40	-10.12		

STC (Dongguan) Company Limited

88 Fulin Nan Road, Daxing, Dongguan, China. (Zip Code: 523 770)
Tel: (86 769) 8111 9666 Fax: (86 769) 8111 8333 E-mail: dgstc@dgstc.org Homepage: www.dgstc.org
This report shall not be reproduced unless with prior written approval from STC (Dongguan) Company Limited.
For Conditions of issuance of this test report, please refer to the cover sheet or Homepage.



STC Test Report

Date: 2016-02-01
No.: DMI22441

Page 12 of 40

Results and limit lines for Conducted Emission:
Limits for Conducted Emission Test, please refer to limit lines (Quasi-Peak and Average) in the following diagram.

Results of Full load mode (DC 230V) (N): Pass
Please refer to the following diagram for individual results.



No.	Frequency MHz	Corr. Factor dB	Reading dBµV	Emission dBµV	Limit dBµV	Margina dB	Notes			
1	0.15172	5.24	48.08	44.72	63.32	40.00	56.38	-12.05	-6.41	
2	0.21078	8.04	44.05	40.68	63.08	46.72	63.58	53.88	-10.49	-3.85
3	0.32703	0.32	39.27	35.78	48.00	45.10	38.80	48.80	-10.21	-8.70
4	0.41660	0.40	37.45	34.16	45.00	43.60	57.54	47.54	-10.85	-3.95
45	0.47813	0.60	36.70	33.50	40.20	43.00	56.37	46.37	-10.14	-8.31
6	4.33934	10.08	30.81	25.88	42.87	35.74	58.00	46.00	-13.13	-10.28

STC (Dongguan) Company Limited

88 Fushan Nan Road, Daxing, Dongguan, China. (Zip Code: 523 770)
Tel: (86 769) 8111 9668 Fax: (86 769) 8111 0322 E-mail: dgstc@dgstc.org Homepage: www.dgstc.org
This report shall not be reproduced unless with prior written approval from STC (Dongguan) Company Limited.
For Conditions of issuance of this test report, please refer to the coverleaf or Homepage.



STC Test Report

Date: 2016-02-01
No.: DM122441

Page 13 of 40

Results and limit lines for Conducted Emission:

Limits for Conducted Emission Test, please refer to limit lines (Quasi-Peak and Average) in the following diagram.

Results of Full load mode (DC 360V) (L): Pass

Please refer to the following diagram for individual results.

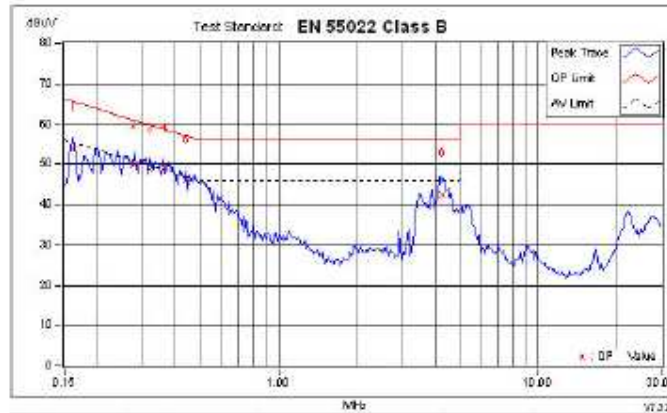

No.	Frequency MHz	Corr. Factor dB	Reading dBµV		Emission dBµV		Limit dBµV		Margin dB		Notes
			QP	AV	QP	AV	QP	AV	QP	AV	
1	0.15172	5.20	48.57	48.48	63.77	60.69	56.38	56.38	-11.60	-4.69	
2	0.22894	4.16	40.78	37.92	49.90	48.88	50.85	50.85	-10.93	-4.17	
3	0.31797	3.23	38.88	35.34	49.81	48.67	50.76	50.76	-10.85	-4.19	
4	0.38004	2.32	39.05	36.39	49.95	48.71	50.71	48.71	-9.70	-3.00	
5	0.43805	1.47	36.81	34.20	49.88	47.67	51.08	47.08	-11.00	-3.41	
6	4.29000	10.01	32.52	25.08	42.01	35.60	50.00	46.00	-13.47	-10.41	

STC (Dongguan) Company Limited

88 Panhu Nan Road, Daxing, Dongguan, China. Zip Code: 523 770
Tel: (86 769) 8111 9666 Fax: (86 769) 8111 0222 E-mail: dgstc@dgstc.org Homepage: www.dgstc.org
This report shall not be reproduced unless with prior written approval from STC (Dongguan) Company Limited.
For Conditions of Issuance of this test report, please refer to the coverlet or Homepage.



STC Test Report

Date: 2016-02-01
No.: DMI22441

Page 14 of 40

Results and limit lines for Conducted Emission:
Limits for Conducted Emission Test, please refer to limit lines (Quasi-Peak and Average) in the following diagram.

Results of Full load mode (DC 360V) (N): Pass
Please refer to the following diagram for individual results.



No.	Frequency MHz	Corr. Factor dB	Reading dBμV		Emission dBμV		Limit dBμV		Margin dB		Notes
			OP	AV	OP	AV	OP	AV	OP	AV	
1	0.15751	-4.95	47.00	42.00	52.00	46.70	56.50	56.50	-13.22	-0.82	
2	0.25021	0.18	38.88	35.67	48.00	45.85	50.70	50.70	-11.67	-4.80	
3	0.37650	0.35	38.16	35.11	47.00	44.40	48.20	48.20	-10.85	-3.80	
4	0.43008	0.46	35.24	32.09	45.70	42.35	47.00	47.00	-11.00	-2.70	
5	0.45220	0.64	35.42	32.00	44.00	42.67	46.20	46.20	-11.05	-3.74	
6	4.32258	10.05	30.58	25.82	40.80	35.87	48.00	48.00	-12.97	-10.23	

STC (Dongguan) Company Limited

88 Fulin Nan Road, Daling, Dongguan, China. (Zip Code: 523770)
Tel: (86 769) 8111 9066 Fax: (86 769) 8111 8222 E-mail: dgstc@dgstc.org Homepage: www.dgstc.org
This report shall not be reproduced unless with prior written approval from STC (Dongguan) Company Limited.
For Conditions of issuance of this test report, please refer to the overleaf or Homepage.



STC Test Report

Date: 2016-02-01
No.: DMI22441

Page 15 of 40

Results and limit lines for Conducted Emission:
Limits for Conducted Emission Test, please refer to limit lines (Quasi-Peak and Average) in the following diagram.

Results of Full load mode (DC 450V) (L): Pass
Please refer to the following diagram for individual results.



No.	Frequency kHz	Corr. Factor dB	Reading dBµV		Emission dBµV		Limit dBµV		Margin dB		Notes
	kHz	dB	GP	AV	GP	AV	GP	AV	GP	AV	
1	0.18172	5.20	49.88	48.89	54.88	52.09	65.38	55.38	-10.40	-9.38	
2	0.26028	0.12	40.45	39.88	40.67	45.75	51.23	51.39	-11.75	-6.57	
3	0.31797	4.21	40.03	37.09	42.58	46.92	59.78	49.78	-10.20	-9.44	
4	0.38438	0.38	38.02	35.70	47.38	45.05	58.18	48.18	-10.80	-2.12	
5	0.47013	4.55	35.78	33.35	45.31	43.90	56.07	46.37	-11.09	-3.47	
6	4.18531	10.00	33.00	25.83	43.00	35.83	55.00	46.00	-13.00	-10.07	

STC (Dongguan) Company Limited

88 Fushihuan Road, Daxing, Dongguan, China. (Zip Code: 523 770)
Tel: (86 769) 8111 9668 Fax: (86 769) 8111 0322 E-mail: dgstc@dgstc.org Homepage: www.dgstc.org
This report shall not be reproduced unless with prior written approval from STC (Dongguan) Company Limited.
For Conditions of issuance of this test report, please refer to the coverleaf or Homepage.



STC Test Report

Date: 2016-02-01
No.: DMI22441

Page 16 of 40

Results and limit lines for Conducted Emission:

Limits for Conducted Emission Test, please refer to limit lines (Quasi-Peak and Average) in the following diagram.

Results of Full load mode (DC 450V) (N): Pass

Please refer to the following diagram for individual results.



No.	Frequency MHz	Cor. Factor	Reading dBμV	Emission dBμV	Limit dBμV	Margins dB	Notes			
1	0.15172	5.24	40.72	40.01	54.00	51.85	55.28	-10.41	-3.52	
2	0.27891	0.19	41.37	37.98	50.65	47.08	50.85	50.85	-10.00	-3.78
3	0.31707	0.25	40.26	39.03	49.51	46.18	50.76	46.76	-10.25	-3.58
4	0.41559	0.40	38.88	34.00	48.40	43.42	57.54	47.54	-11.15	-4.11
5	0.47818	0.63	35.94	32.01	44.07	42.44	56.37	48.37	-11.40	-3.03
6	4.32813	10.08	33.39	25.57	42.35	35.83	58.00	48.00	-13.65	-10.07

Remark:

Calculated measurement uncertainty (0.15MHz - 30MHz): 3.2dB

STC (Dongguan) Company Limited

88 Fulin Nan Road, Daxing, Dongguan, China. (Zip Code: 523 770)
Tel: (86 768) 8111 9666 Fax: (86 768) 8111 8333 E-mail: dgstc@dgstc.org Homepage: www.dgstc.com
This report shall not be reproduced unless with prior written approval from STC (Dongguan) Company Limited.
For Conditions of Issuance of this test report, please refer to the cover sheet or Homepage.



STC Test Report

Date: 2016-02-01
No.: DMI22441

Page 17 of 40

3.1.3 Harmonic current emissions

Test Requirement: EN 61000-3-2
Test Method: EN 61000-3-2
Level: Class A

Mode of Operation: All modes

Test Method:

The test was performed in accordance with EN 61000-3-2.

Test Procedure:

The EUT is a PV Inverter, the test was conducted during the all modes test function to simulate the normal usage as well as to produce the maximum electromagnetic disturbances.

STC (Dongguan) Company Limited

88 Fuzhi Nan Road, Daling, Dongguan, China. (Zip Code: 523 770)
Tel: (86 769) 8111 9666 Fax: (86 769) 8111 0222 E-mail: dgstc@dgstc.org Homepage: www.dgstc.org
This report shall not be reproduced unless with prior written approval from STC (Dongguan) Company Limited.
For Conditions of Issuance of this test report, please refer to the coverleaf or Homepage.



STC Test Report

Date: 2016-02-01
No.: DM122441

Page 18 of 40

Results and limit line for Harmonics Emissions:

Results : Pass
Please refer to the following table for individual results.

(Average)

Order	Measure[A]	Limit[A]	Margin[%]	Order	Measure[A]	Limit[A]	Margin[%]
1	12.1882			2	0.0019	1.0800	99.2
3	0.1580	2.3000	93.1	4	0.0047	0.4300	98.8
5	0.0319	1.1400	97.2	6	0.0037	0.3000	99.0
7	0.0138	0.7700	98.2	8	0.0031	0.2000	98.7
9	0.0074	0.4000	98.6	10	0.0042	0.1840	97.7
11	0.0039	0.3300	98.2	12	0.0037	0.1535	97.6
13	0.0017	0.2100	94.3	14	0.0040	0.1314	96.9
15	0.0010	0.1500	93.2	16	0.0032	0.1150	97.3
17	0.0012	0.1324	90.9	18	0.0029	0.1022	97.7
19	0.0018	0.1164	88.3	20	0.0020	0.0950	97.2
21	0.0016	0.1071	86.3	22	0.0016	0.0830	97.8
23	0.0011	0.0978	89.0	24	0.0010	0.0757	97.9
25	0.0011	0.0900	85.2	26	0.0019	0.0706	97.3
27	0.0010	0.0833	86.4	28	0.0011	0.0657	97.3
29	0.0011	0.0776	84.7	30	0.0011	0.0613	97.8
31	0.0007	0.0706	85.3	32	0.0012	0.0578	98.0
33	0.0004	0.0682	88.1	34	0.0012	0.0541	97.7
35	0.0001	0.0643	85.9	36	0.0011	0.0511	97.8
37	0.0019	0.0608	87.1	38	0.0013	0.0484	97.2
39	0.0007	0.0577	88.6	40	0.0012	0.0460	97.4

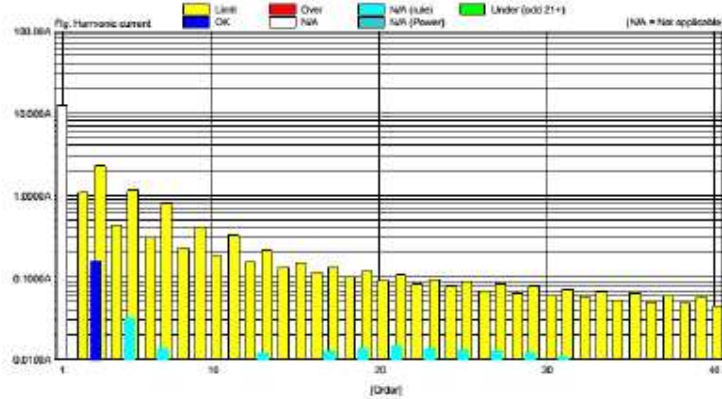

STC (Dongguan) Company Limited

88 Fushin Nan Road, Dongguan, China. (Zip Code: 523 770)
Tel: (86 768) 8111 8666. Fax: (86 768) 8111 8222. E-mail: dgstc@dgstc.org | Homepage: www.dgstc.org
This report shall not be reproduced unless with prior written approval from STC (Dongguan) Company Limited.
For Conditions of Issuance of this test report, please refer to the overleaf or Homepage.



STC Test Report

Date: 2016-02-01
No.: DMI22441

Page 19 of 40

Results and limit line for Harmonics Emissions:

Results : Pass
Please refer to the following table for individual results.

(Maximum)

Order	Measure(A)	Limit(A)	Margin(%)	Order	Measure(A)	Limit(A)	Margin(%)
1	12.1925	3.4500	98.4	2	0.0007	1.0200	99.5
3	0.0093	0.6000	99.0	4	0.0005	0.6500	99.0
5	0.0025	1.7100	98.1	5	0.0008	0.4500	99.2
7	0.0016	1.1550	98.7	8	0.0004	0.3450	99.0
9	0.0008	0.6000	99.0	10	0.0007	0.2700	98.3
11	0.0005	0.4950	98.7	12	0.0002	0.2300	98.2
13	0.0002	0.3750	95.9	14	0.0001	0.1971	97.4
15	0.0002	0.2250	98.2	15	0.0002	0.1225	98.0
17	0.0004	0.1985	93.3	18	0.0002	0.1533	98.2
19	0.0002	0.1775	92.0	20	0.0002	0.1300	97.9
21	0.0002	0.1607	90.7	22	0.0001	0.1295	98.4
23	0.0002	0.1497	90.5	24	0.0001	0.1150	98.4
25	0.0002	0.1350	89.9	25	0.0002	0.1082	98.0
27	0.0002	0.1250	89.4	28	0.0002	0.0986	98.0
29	0.0001	0.1164	89.6	30	0.0001	0.0920	98.4
31	0.0001	0.1089	90.0	32	0.0001	0.0862	98.5
33	0.0000	0.1023	90.6	34	0.0001	0.0812	98.3
35	0.0000	0.0964	90.4	36	0.0001	0.0767	98.4
37	0.0000	0.0912	91.1	38	0.0001	0.0726	97.9
39	0.0000	0.0865	90.8	40	0.0001	0.0680	97.9

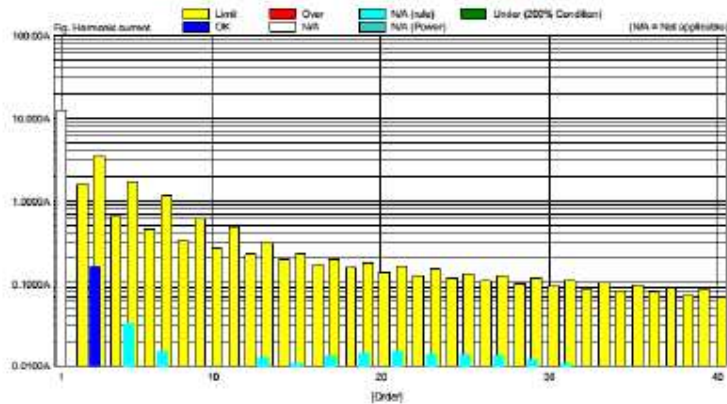

Remark:
Calculated measurement uncertainty: 7.11%

STC (Dongguan) Company Limited

88 Fulin Nan Road, Daxing, Dongguan, China. (Zip Code: 523 770)
Tel: (86 769) 8111 9668 Fax: (86 769) 8111 0322 E-mail: dgstc@dgstc.org Homepage: www.dgstc.org
This report shall not be reproduced unless with prior written approval from STC (Dongguan) Company Limited.
For Conditions of issuance of this test report, please refer to the coverleaf or Homepage.



STC Test Report

Date: 2016-02-01
No.: DM122441

Page 20 of 40

3.1.4 Voltage fluctuations & Flicker

Test Requirement:	EN 61000-3-3
Test Method:	EN 61000-3-3
Limits:	Pst=1 dc(%)=3.3% dMax(%)=4% d(t)-3.3%≠500ms

Mode of Operation: All modes

Test Method:

The test was performed in accordance with EN 61000-3-3.

Test Procedure:

The EUT is a PV Inverter, the test was conducted during the all modes test function to simulate the normal usage as well as to produce the maximum electromagnetic disturbances.

STC (Dongguan) Company Limited

88 Famin Nan Road, Daxing, Dongguan, China. (Zip Code : 523 770)
Tel : (86 769) 8111 9966. Fax : (86 769) 8111 0222. E-mail : dgstc@dgstc.org Homepage : www.dgstc.org
This report shall not be reproduced unless with prior written approval from STC (Dongguan) Company Limited.
For Conditions of Issuance of this test report, please refer to the overleaf or Homepage.



STC Test Report

Date: 2016-02-01
No.: DMI22441

Page 21 of 40

Limits for Flicker:
Please refer to the result table for details.

Results: Pass
Please refer to the following table for individual results.

No.	ctc[%]	cimax[%]	ct'(rms)	Pst
1	0.00	0.00	0.00	0.07
2	0.00	0.00	0.00	0.07
3	0.00	0.00	0.00	0.07
4	0.00	0.00	0.00	0.07
5	0.00	0.00	0.00	0.07
6	0.00	0.00	0.00	0.07
7	0.00	0.00	0.00	0.07
8	0.00	0.00	0.00	0.07
9	0.00	0.00	0.00	0.07
10	0.00	0.00	0.00	0.07
11	0.00	0.00	0.00	0.07
12	0.00	0.00	0.00	0.07

Pst
0.07

Remarks:
Calculated measurement uncertainty: 7.7%

STC (Dongguan) Company Limited

88 Fushin Nan Road, Cailing, Dongguan, China. (Zip Code: 523 770)
Tel: (86 769) 8111 8666. Fax: (86 769) 8111 8222. E-mail: dgstc@dgstc.org Homepage: www.dgstc.org
This report shall not be reproduced unless with prior written approval from STC (Dongguan) Company Limited.
For Conditions of Issuance of this test report, please refer to the coverleaf or Homepage.



STC Test Report

Date: 2016-02-01
No.: DMI22441

Page 22 of 40

3.2 Immunity

3.2.1 Susceptibility Performance Criteria

A	The apparatus shall continue to operate as intended during and after the test. No degradation of performance or loss of function is allowed below a performance level specified by the manufacturer, when the apparatus is used as intended. The performance level may be replaced by a permissible loss of performance. If the minimum performance level or the permissible performance loss is not specified by the manufacturer, either of these may be derived from the product description and documentation and what the user may reasonably expect from the apparatus if used as intended.
B	The apparatus shall continue to operate as intended after the test. No degradation of performance or loss of function is allowed below a performance level specified by the manufacturer, when the apparatus is used as intended. The performance level may be replaced by a permissible loss of performance. During the test, degradation of performance is however allowed. No change of actual operating state or stored data is allowed. If the minimum performance level or the permissible performance loss is not specified by the manufacturer, either of these may be derived from the product description and documentation and what the user may reasonably expect from the apparatus if used as intended.
C	Temporary loss of function is allowed, provided the function is self-recoverable or can be restored by the operation of the controls.
D	Degradation or loss of function which is not recoverable due to damage of equipment (components) or software, or loss of data

STC (Dongguan) Company Limited

88 Famin Han Road, Daling, Dongguan, China. (Zip Code: 523 770)
Tel: (86 769) 8111 9666 Fax: (86 769) 8111 0222 E-mail: dgstc@dgstc.org Homepage: www.dgstc.org
This report shall not be reproduced unless with prior written approval from STC (Dongguan) Company Limited.
For Conditions of Issuance of this test report, please refer to the coverleaf or Homepage.



STC Test Report

Date: 2016-02-01
No.: DMI22441

Page 23 of 40

3.2.2 Electrostatic Discharge

Test Requirement: IEC 61000-4-2
Test Method: IEC 61000-4-2
Severity: $\pm 2\text{kV}$, $\pm 4\text{kV}$, $\pm 6\text{kV}$ for Direct & Indirect Contact Discharge
 $\pm 2\text{kV}$, $\pm 4\text{kV}$, $\pm 8\text{kV}$ for Air Discharge

Performance Criterion Requirement: B

Temperature: 21.3 °C
Humidity: 51.0 %
Atmospheric Pressure: 101.3 kPa

Test Date(s): 2016-01-29

Mode of Operation: 10% load mode

Test Method:

The test was performed in accordance with IEC 61000-4-2.

Test Procedure:

The EUT is a PV Inverter, the test was conducted during the 10% load test function to simulate the normal usage specified by the manufacturer.

Test Setup:

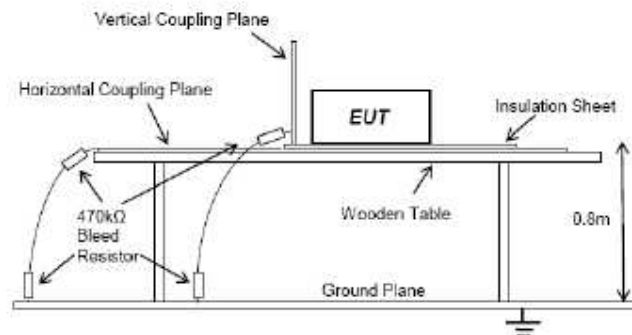

STC (Dongguan) Company Limited

88 Fushin Nan Road, Daling, Dongguan, China. (Zip Code: 523 770)
Tel: (86 769) 8111 9066 Fax: (86 769) 8111 8222 E-mail: dgstc@dgstc.org Homepage: www.dgstc.org
This report shall not be reproduced unless with prior written approval from STC (Dongguan) Company Limited.
For Conditions of Issuance of this test report, please refer to the coverleaf or Homepage.



STC Test Report

Date: 2016-02-01
No.: DMI22441

Page 24 of 40

Severity Levels for Electrostatic Discharge:

Level	Test Voltage Direct & Indirect Contact Discharge	Test Voltage Air Discharge
1	±2kV	±2kV
2	±4kV	±4kV
3	±6kV	±6kV
4	±8kV	±7kV

Results: Pass

Please refer to the following table for individual results.

Location	Discharge Method	Test Voltage	Individual Results	
			Pass	Failed
HCP [Horizontal Coupling Plane]	Indirect Contact	±2kV, ±4kV, ±6kV	<input checked="" type="checkbox"/>	<input type="checkbox"/>
VCP [Vertical Coupling Plane]	Indirect Contact	±2kV, ±4kV, ±6kV	<input checked="" type="checkbox"/>	<input type="checkbox"/>
All Metal Parts	Direct Contact	±2kV, ±4kV, ±6kV	<input checked="" type="checkbox"/>	<input type="checkbox"/>
All Non-Metal Parts	Air	±2kV, ±4kV, ±6kV	<input checked="" type="checkbox"/>	<input type="checkbox"/>
***EUT Grounding		<input checked="" type="checkbox"/> Grounded	<input type="checkbox"/> Ungrounded	

Remarks:

***For ungrounded EUT, the charge on the EUT shall be removed prior to each applied ESD pulse
Calculated measurement uncertainty: 7.1%

STC (Dongguan) Company Limited

88 Fuzhi Nan Road, Daxing, Dongguan, China. (Zip Code: 523 770)
Tel: (86 769) 8111 9668 Fax: (86 769) 8111 0222 E-mail: dgstc@dgstc.org Homepage: www.dgstc.org
This report shall not be reproduced unless with prior written approval from STC (Dongguan) Company Limited.
For Conditions of issuance of this test report, please refer to the coverleaf or Homepage.



STC Test Report

Date: 2016-02-01
No.: DMI22441

Page 25 of 40

3.2.3 Radiated Immunity [80MHz to 1000MHz, 1400-2000MHz, 2000-2700MHz]

Test Requirement: IEC 61000-4-3
Test Method: IEC 61000-4-3
Severity: Level 3 [10V/m]
Modulation: 80% 1kHz AM

Performance Criterion Requirement: A

Temperature: 21.6 °C
Humidity: 57.5 %

Test Date(s): 2016-01-29

Mode of Operation: 10% load mode

Test Method:

The test was performed in accordance with IEC 61000-4-3.

Test Procedure:

The EUT is a PV Inverter, the test was conducted during the 10% load test function to simulate the normal usage specified by the manufacturer.

Test Setup:

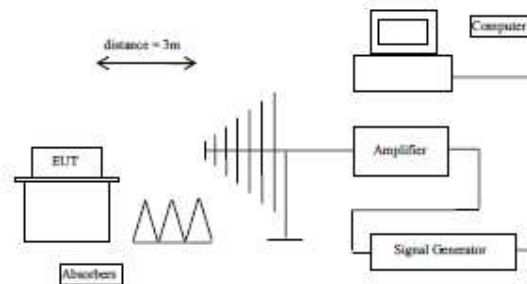

STC (Dongguan) Company Limited

88 Fulin Nan Road, Daling, Dongguan, China. (Zip Code: 523 770)
Tel: (86 769) 8111 9666 Fax: (86 769) 8111 8333 E-mail: dgstc@dgstc.org Homepage: www.dgstc.org
This report shall not be reproduced unless with prior written approval from STC (Dongguan) Company Limited.
For Conditions of issuance of this test report, please refer to the cover sheet or Homepage.



STC Test Report

Date: 2016-02-01
No.: DM122441

Page 26 of 40

Severity Levels for Radiated Immunity:

Level	Field Strength [V/m]
1	1
2	3
3	10

Results: Pass

Please refer to the following table for individual results.

Frequency (MHz)	Face	Polarity	Level (V/m)	Dwell Time (s)	Sweep rate (%)	Individual Results	
						Pass	Failed
80-1000	0°, 90°, 180°, 270°	Horizontal	10	3	1	<input checked="" type="checkbox"/>	<input type="checkbox"/>
1400-2000	0°, 90°, 180°, 270°	Horizontal	10	3	1	<input checked="" type="checkbox"/>	<input type="checkbox"/>
2000-2700	0°, 90°, 180°, 270°	Horizontal	10	3	1	<input checked="" type="checkbox"/>	<input type="checkbox"/>
80-1000	0°, 90°, 180°, 270°	Vertical	10	3	1	<input checked="" type="checkbox"/>	<input type="checkbox"/>
1400-2000	0°, 90°, 180°, 270°	Vertical	10	3	1	<input checked="" type="checkbox"/>	<input type="checkbox"/>
2000-2700	0°, 90°, 180°, 270°	Vertical	10	3	1	<input checked="" type="checkbox"/>	<input type="checkbox"/>

Remarks:

The dwell time at each frequency is according to the standard being applied and the basic standard
Calculated measurement uncertainty: 1.74dB

STC (Dongguan) Company Limited

88 Fushin Nan Road, Daling, Dongguan, China. (Zip Code: 523 770)
Tel: (86 769) 8111 9056 Fax: (86 769) 8111 8222 E-mail: dgstc@dgstc.org Homepage: www.dgstc.org
This report shall not be reproduced unless with prior written approval from STC (Dongguan) Company Limited.
For Conditions of issuance of this test report, please refer to the overleaf or Homepage.



STC Test Report

Date: 2016-02-01
No.: DMI22441

Page 27 of 40

3.2.4 Electrical Fast Transients

Test Requirement:	IEC 61000-4-4
Test Method:	IEC 61000-4-4
Severity:	Level 3 [$\pm 2kV$]
Performance Criterion Requirement:	B
Temperature:	21.5 °C
Humidity:	58.2 %
Test Date(s):	2016-01-29
Mode of Operation:	10% load mode

Test Method:
The test was performed in accordance with IEC 61000-4-4.

Test Procedure:
The EUT is a PV Inverter, the test was conducted during the 10% load test function to simulate the normal usage specified by the manufacturer.

Test Setup:

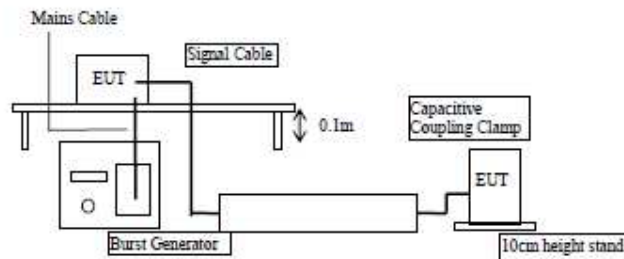

STC (Dongguan) Company Limited

88 Fumin Nan Road, Daling, Dongguan, China. (Zip Code: 523 770)
Tel: (86 769) 8111 9066 Fax: (86 769) 8111 8222 E-mail: dgstc@dgstc.org Homepage: www.dgstc.org
This report shall not be reproduced unless with prior written approval from STC (Dongguan) Company Limited.
For Conditions of issuance of this test report, please refer to the overleaf or Homepage.



STC Test Report

Date: 2016-02-01
No.: DM122441

Page 28 of 40

Severity Levels for Electrical Fast Transient:

Level	On power supply port, PE		On I/O (Input/Output) signal, data and control ports	
	Voltage peak [kV]	Repetition rate [kHz]	Voltage peak [kV]	Repetition rate [kHz]
1	0.5	5.0	0.25	5.0
2	1.0	5.0	0.50	5.0
3	2.0	5.0	1.00	5.0
4	4.0	2.5	2.00	5.0

Results: Pass

Please refer to the following table for individual results.

Conductor	Polarity & Level	Duration/Polarity (s)	Individual Results	
			Pass	Failed
Live	±2kV	120	<input checked="" type="checkbox"/>	<input type="checkbox"/>
Neutral	±2kV	120	<input checked="" type="checkbox"/>	<input type="checkbox"/>
PE	±2kV	120	<input checked="" type="checkbox"/>	<input type="checkbox"/>
Live-Neutral	±2kV	120	<input checked="" type="checkbox"/>	<input type="checkbox"/>
Live-PE	±2kV	120	<input checked="" type="checkbox"/>	<input type="checkbox"/>
Neutral-PE	±2kV	120	<input checked="" type="checkbox"/>	<input type="checkbox"/>
Live-Neutral-PE	±2kV	120	<input checked="" type="checkbox"/>	<input type="checkbox"/>
DC Line	±2kV	120	<input checked="" type="checkbox"/>	<input type="checkbox"/>

Remark:

Calculated measurement uncertainty: 7.1%

STC (Dongguan) Company Limited

88 Fumin Nan Road, Daling, Dongguan, China, (Zip Code: 523 770)
Tel: (86 769) 8111 9688 Fax: (86 769) 8111 8222 E-mail: dgstc@dgstc.org Homepage: www.dgstc.org
This report shall not be reproduced unless with prior written approval from STC (Dongguan) Company Limited.
For Conditions of Issuance of this test report, please refer to the coverleaf or Homepage.



STC Test Report

Date: 2016-02-01
No.: DM122441

Page 29 of 40

3.2.5 Surge Immunity on AC Supply

Test Requirement: IEC 61000-4-5
Test Method: IEC 61000-4-5
Severity: Level 2- 1.0kV (between phase & phase)
Level 3 -2.0kV (between phase & earth)

Performance Criterion Requirement: B

Temperature: 21.5 °C
Humidity: 59.2 %
Test Date(s): 2016-01-29
Mode of Operation: 10% load mode

Test Method:

The test was performed in accordance with IEC 61000-4-5.

Test Procedure:

The EUT is a PV Inverter, the test was conducted during the 10% load test function to simulate the normal usage specified by the manufacturer.

Test Setup:

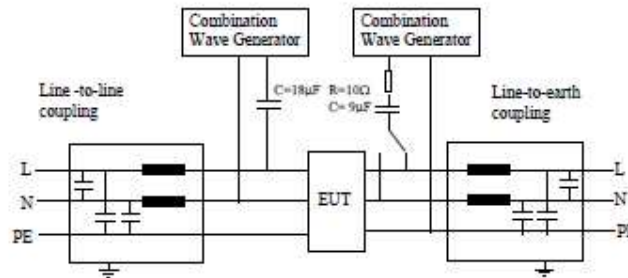

STC (Dongguan) Company Limited

65 Fanchi Nan Road, Daling, Dongguan, China. (Zip Code: 523770)
Tel: (86 769) 8111 9888 Fax: (86 769) 8111 6222 E-mail: dgstc@dgstc.org Homepage: www.dgstc.org
This report shall not be reproduced unless with prior written approval from STC (Dongguan) Company Limited.
For Conditions of Issuance of this test report, please refer to the coverleaf or Homepage.



STC Test Report

Date: 2016-02-01
No.: DMI22441

Page 30 of 40

Severity Levels for Surge Immunity:

Level	Open-circuit test voltage $\pm 10\%$
1	0.5 kV
2	1.0 kV
3	2.0 kV
4	4.0 kV

Results: Pass

Please refer to the following table for individual results.

Conductor	Level & Polarity	No. of Surge	Phase Angle	Surge Interval	Individual Results	
					Pass	Failed
Live - Neutral	$\pm 1.0\text{kV}$	5	0°	60s	<input checked="" type="checkbox"/>	<input type="checkbox"/>
			90°		<input checked="" type="checkbox"/>	<input type="checkbox"/>
			180°		<input checked="" type="checkbox"/>	<input type="checkbox"/>
			270°		<input checked="" type="checkbox"/>	<input type="checkbox"/>
Live - PE	$\pm 2.0\text{kV}$	5	0°	60s	<input checked="" type="checkbox"/>	<input type="checkbox"/>
			90°		<input checked="" type="checkbox"/>	<input type="checkbox"/>
			180°		<input checked="" type="checkbox"/>	<input type="checkbox"/>
			270°		<input checked="" type="checkbox"/>	<input type="checkbox"/>
Neutral - PE	$\pm 2.0\text{kV}$	5	0°	60s	<input checked="" type="checkbox"/>	<input type="checkbox"/>
			90°		<input checked="" type="checkbox"/>	<input type="checkbox"/>
			180°		<input checked="" type="checkbox"/>	<input type="checkbox"/>
			270°		<input checked="" type="checkbox"/>	<input type="checkbox"/>

Remark:

Calculated measurement uncertainty: 0.23kV

STC (Dongguan) Company Limited

88 Fushan Nan Road, Daxing, Dongguan, China. (Zip Code: 523 770)
Tel: (86 769) 8111 9666 Fax: (86 769) 8111 0222 E-mail: dgstc@dgstc.org Homepage: www.dgstc.org
This report shall not be reproduced unless with prior written approval from STC (Dongguan) Company Limited.
For Conditions of Issuance of this test report, please refer to the coverleaf or Homepage.



STC Test Report

Date: 2016-02-01
No.: DMI22441

Page 31 of 40

3.2.6 Continuous RF Immunity (150kHz to 80MHz)
 Test Requirement: IEC 61000-4-6
 Test Method: IEC 61000-4-6
 Severity: Level 3 - 10Vrms(emf) with 80% 1kHz AM

Performance Criterion Requirement: A

Temperature: 22.5 °C
 Humidity: 56.6 %
 Test Date(s): 2016-01-29
 Mode of Operation: 10% load mode

Test Method:
 The test was performed in accordance with IEC 61000-4-6.

Test Procedure:
 The EUT is a PV Inverter, the test was conducted during the 10% load test function to simulate the normal usage specified by the manufacturer.

Test Setup:

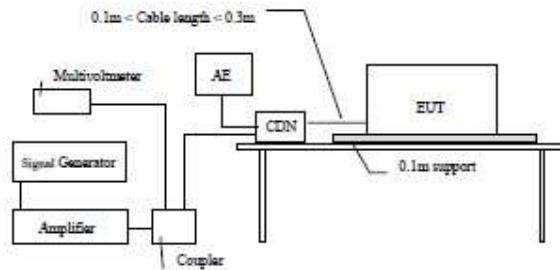

STC (Dongguan) Company Limited

88 Fushih Nan Road, Daxing, Dongguan, China. (Zip Code: 523 370)
 Tel: (86 768) 8111 8868 Fax: (86 768) 8111 8222 E-mail: dgstc@dgstc.org Homepage: www.dgstc.org
 This report shall not be reproduced unless with prior written approval from STC (Dongguan) Company Limited.
 For Conditions of Issuance of this test report, please refer to the overleaf or Homepage.



STC Test Report

Date: 2016-02-01
No.: DMI22441

Page 32 of 40

Severity Levels for Continuous RF Immunity:

Level	Frequency range 150kHz - 80MHz	
	Voltage level (emf)	
	U ₀ [dB(μV)]	U ₀ [V]
1	120	1
2	130	3
3	140	10

Results: Pass

Please refer to the following table for individual results.

DC Line:

Frequency (MHz)	Level (V _{rms})	Dwell Time (s)	Sweep rate (%)	Individual Results	
				Pass	Failed
150kHz - 80MHz	10	3	1	<input checked="" type="checkbox"/>	<input type="checkbox"/>

AC Mains:

Frequency (MHz)	Level (V _{rms})	Dwell Time (s)	Sweep rate (%)	Individual Results	
				Pass	Failed
150kHz - 80MHz	10	3	1	<input checked="" type="checkbox"/>	<input type="checkbox"/>

Remark:

Calculated measurement uncertainty: 2.3dB

STC (Dongguan) Company Limited

88 Fanzhi Nan Road, Daling, Dongguan, China. (Zip Code: 523 770)
Tel: (86 769) 8111 9668 Fax: (86 769) 8111 0222 E-mail: dgstc@dgstc.org Homepage: www.dgstc.org
This report shall not be reproduced unless with prior written approval from STC (Dongguan) Company Limited.
For Conditions of issuance of this test report, please refer to the coverleaf or Homepage.



STC Test Report

Date: 2016-02-01
No.: DMI22441

Page 33 of 40

3.2.7 Power Frequency Magnetic Field

Test Requirement: IEC 61000-4-8
Test Method: IEC 61000-4-8
Severity: 30 A/m (Continuous)

Performance Criterion Requirement: A

Temperature: 22 °C
Humidity: 59 %

Test Date(s): 2016-01-29

Mode of Operation: 10% load mode

Test Method:

The test was performed in accordance with IEC 61000-4-8

Test Procedure:

The EUT is a PV Inverter, the test was conducted during the 10% load test function to simulate the normal usage specified by the manufacturer.

Test Setup:

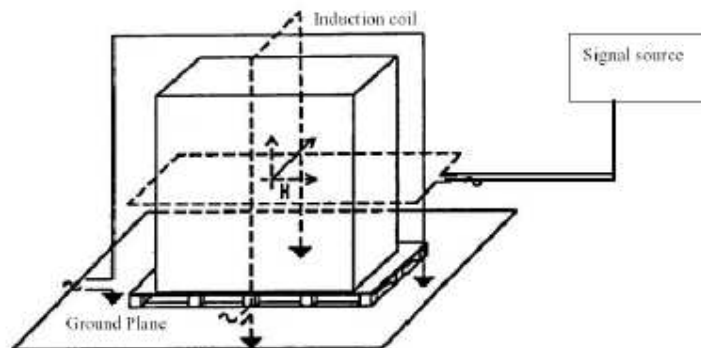

STC (Dongguan) Company Limited

88 Famin Nan Road, Daling, Dongguan, China. (Zip Code: 523 770)
Tel: (86 769) 8111 9666 Fax: (86 769) 8111 8222 E-mail: dgstc@dgstc.org Homepage: www.dgstc.org
This report shall not be reproduced unless with prior written approval from STC (Dongguan) Company Limited.
For Conditions of issuance of this test report, please refer to the overleaf of Homepage.



STC Test Report

Date: 2016-02-01
No.: DMI22441

Page 34 of 40

Severity Levels for Power Frequency Magnetic Field:

Level	Magnetic field strength A/m
1	1
2	3
3	10
4	30
5	100
X ⁽¹⁾	special
NOTE 1 "X" is an open level. This level can be given in the product specification	

Results: Pass

Please refer to the following table for individual results.

Test Level	EUT Orientation	Individual Results	
		Pass	Failed
30 A/m (Continuous)	X, Y, Z	<input checked="" type="checkbox"/>	<input type="checkbox"/>

Remark:

Calculated measurement uncertainty: 7.1%

STC (Dongguan) Company Limited

88 Fulin Nan Road, Daxing, Dongguan, China. (Zip Code: 523 770)
Tel: (86 769) 8111 9688 Fax: (86 769) 8111 8222 E-mail: dgstc@dgstc.org Homepage: www.dgstc.org
This report shall not be reproduced unless with prior written approval from STC (Dongguan) Company Limited.
For Conditions of issuance of this test report, please refer to the overleaf or Homepage.



STC Test Report

Date: 2016-02-01
No.: DMI22441

Page 35 of 40

3.2.8 Common Mode Disturbance

Test Requirement: IEC 61000-4-16
Test Method: IEC 61000-4-16
Severity: 100V, 300V

Performance Criterion Requirement: A

Temperature: 28 °C
Humidity: 52 %

Test Date(s): 2016-01-29

Mode of Operation: 10% load mode

Test Method:

The test was performed in accordance with IEC 61000-4-16

Test Procedure:

The EUT is an PV inverter, the test was conducted during the 10% load test function to simulate the normal usage specified by the manufacturer.

Test Setup:

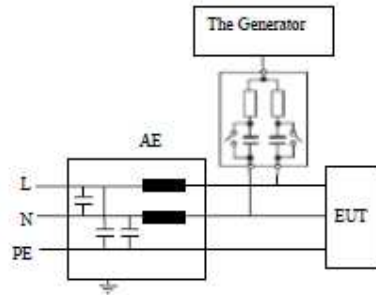

STC (Dongguan) Company Limited

88 Fanyin Nan Road, Daling, Dongguan, China. (Zip Code: 523 770)
Tel: (86 769) 8111 9666 Fax: (86 769) 8111 0222 E-mail: dgstc@dgstc.org Homepage: www.dgstc.org
This report shall not be reproduced unless with prior written approval from STC (Dongguan) Company Limited.
For Conditions of issuance of this test report, please refer to the coverleaf or Homepage.



STC Test Report

Date: 2016-02-01
No.: DMI22441

Page 36 of 40

Severity Levels for continuous disturbance:

Level	Open circuit test voltage V (r.m.s.)
1	1
2	3
3	10
4	30
X ⁽¹⁾	special

NOTE 1 "X" is an open level. This level may be defined in the product standard.

Severity Levels for for short duration disturbance:

Level	Open circuit test voltage V (r.m.s.)
1	10
2	30
3	100
4	300
X ⁽¹⁾	special

NOTE 1 "X" is an open level. This level may be defined in the product standard.

Results: Pass
Please refer to the following table for individual results.

Short Duration (Common mode)

Test Terminal	Test Level V	Frequency Hz	Dwell Time	Individual Results	
				Pass	Failed
Output Power	300	50	2S	<input checked="" type="checkbox"/>	<input type="checkbox"/>

Short Duration (Difference mode)

Test Terminal	Test Level V	Frequency	Dwell Time	Individual Results	
				Pass	Failed
Output Power	100	50	2S	<input checked="" type="checkbox"/>	<input type="checkbox"/>

STC (Dongguan) Company Limited

88 Fulin Nan Road, Daling, Dongguan, China. (Zip Code: 523 770)
Tel: (86 769) 8111 9666 Fax: (86 769) 8111 8333 E-mail: dgstc@dgstc.org Homepage: www.dgstc.org
This report shall not be reproduced unless with prior written approval from STC (Dongguan) Company Limited.
For Conditions of Issuance of this test report, please refer to the overleaf or Homepage.



STC Test Report

Date: 2016-02-01
No.: DMI22441

Page 37 of 40

3.2.9 Oscillatory Waves:

Test Requirement: IEC 61000-4-18
Test Method: IEC 61000-4-18
Severity: 1kV, 2.5kV

Performance Criterion Requirement: B

Temperature: 26 °C
Humidity: 51 %

Test Date(s): 2016-01-29

Mode of Operation: 10% Load Mode

Test Method:

The test was performed in accordance with IEC 61000-4-18

Test Procedure:

The EUT is an PV inverter, the test was conducted during the 10% load test function to simulate the normal usage specified by the manufacturer.

Test Setup:

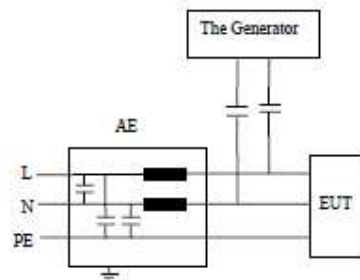

STC (Dongguan) Company Limited

88 Fushan Nan Road, Daxing, Dongguan, China. (Zip Code: 523 770)
Tel: (86 769) 8111 9068 Fax: (86 769) 8111 0222 E-mail: dgstc@dgstc.org Homepage: www.dgstc.org
This report shall not be reproduced unless with prior written approval from STC (Dongguan) Company Limited.
For Conditions of Issuance of this test report, please refer to the overleaf or Homepage.



STC Test Report

Date: 2016-02-01
No.: DMI22441

Page 38 of 40

Severity Levels for Oscillatory Waves Field:

Test levels for the slow damped oscillatory wave(100KHz or 1MHz)

Level	Common mode kV	Differential mode kV
1	0.5	0.25
2	1	0.5
3	2*	1
4	-	-
X ^o	X	X

NOTE:

* The Value is increased to 2.5kV for substation equipment.

"X" is an open level, above, below or in-between the other levels. This level can be give in the product standard.

Test levels for the fast damped oscillatory wave (3MHz, 10MHz or 30MHz)

Level	Common mode kV
1	0.5
2	1
3	2
4	4
X ^o	X

NOTE :

"X" can be any level, above, below or in-between the other levels. This level can be give in the product standard.

Results: **Pass**

Please refer to the following table for individual results.

Conductor	Level & Polarity	Oscillation Frequency	Number of Pulses	Surge Interval	Individual Results	
					Pass	Failed
Live - Neutral	±1.0kV	1MHz	400%	60s	<input checked="" type="checkbox"/>	<input type="checkbox"/>
Live - PE	±2.5kV	1MHz	400%	60s	<input checked="" type="checkbox"/>	<input type="checkbox"/>
Neutral - PE	±2.5kV	1MHz	400%	60s	<input checked="" type="checkbox"/>	<input type="checkbox"/>

Remark:

Calculated measurement uncertainty: 7.1%

STC (Dongguan) Company Limited

89 Fumin Nan Road, Daxing, Dongguan, China. (Zip Code: 523 770)
Tel: (86 755) 8111 9688 Fax: (86 755) 8111 8222 E-mail: dgstc@sgps.org Homepage: www.sgps.org
This report shall not be reproduced unless with prior written approval from STC (Dongguan) Company Limited.
For Conditions of issuance of this test report, please refer to the overleaf or Homepage.



STC Test Report

Date: 2016-02-01
No.: DMI22441

Page 39 of 40

3.2.10 DC Voltage Dips and Interruptions
Test Requirement: IEC 61000-4-29
Test Method: IEC 61000-4-29

Performance Criterion Requirement: B

Temperature: 28 °C
Humidity: 52 %

Test Date(s): 2015-01-07

Mode of Operation: 10% load mode

Test Method:
The test was performed in accordance with IEC 61000-4-29

Test Procedure:
The EUT is an PV inverter, the test was conducted during the 10% load test function to simulate the normal usage specified by the manufacturer.

STC (Dongguan) Company Limited

88 Fuzhi Nan Road, Daxing, Dongguan, China. (Zip Code: 523 770)
Tel: (86 769) 8111 9668 Fax: (86 769) 8111 0322 E-mail: dgstc@dgstc.org Homepage: www.dgstc.org
This report shall not be reproduced unless with prior written approval from STC (Dongguan) Company Limited.
For Conditions of issuance of this test report, please refer to the coverleaf or Homepage.



STC Test Report

Date: 2016-02-01
No.: DMI22441

Page 40 of 40

Severity Levels for DC Voltage Dips and Interruptions immunity:
Preferred test levels and durations for voltage dips

Test	Test level % U _T	Duration (s)
Voltage dips	40 and 70 or x	0.01
		0.03
		0.1
		0.3
		1
		x

Preferred test levels and durations for short interruptions

Test	Test level % U _T	Duration (s)
Short interruptions	High impedance and/or Low impedance	0.001
		0.003
		0.01
		0.03
		0.1
		0.3
		1
		x

Preferred test levels and durations for voltage variations

Test	Test level % U _T	Duration (s)
Voltage variations	85 and 120 or 80 and 120 or x	0.1
		0.3
		1
		3
		10
		x

Results: Pass
Please refer to the following table for individual results.

U_T = 300V d.c.

Test Level (% of U _T)	Duration (ms)	Event Interval (sec)	Duration (Times)	Individual Results	
				Pass	Failed
0%	50	10	3	<input checked="" type="checkbox"/>	<input type="checkbox"/>

Remarks:
Calculated measurement uncertainty: 0.13% of tested voltage
U_T - The nominal supply voltage

*****End of Test Report*****

STC (Dongguan) Company Limited

88 Fuzhi Nan Road, Daxing, Dongguan, China. (Zip Code: 523 770)
Tel: (86 768) 8111 9668 Fax: (86 768) 8111 0322 E-mail: dgstc@dgstc.org Homepage: www.dgstc.org
This report shall not be reproduced unless with prior written approval from STC (Dongguan) Company Limited.
For Conditions of Issuance of this test report, please refer to the coverleaf or Homepage.



STC Test Report

Date: 2016-02-01
No.: DMI22441

APPENDIX A

Page A1 of A3

List of Measurement Equipment

Radiated Emission

Equipment	Manufacturer	Model No.	Serial No.	Last Cal.	Next Cal.
EMI Test Receiver	Rohde&Schwarz	ESCI	100962	Mar. 05.15	Mar. 04.16
EMI Test Receiver	Rohde&Schwarz	ESCI	101418	Mar. 05.15	Mar. 04.16
Inlog-Broadband Antenna	SCHWARZBECK	VULB 9168	9168-355	Nov. 20.15	Nov. 19.16
Inlog-Broadband Antenna	SCHWARZBECK	VULB 9168	9168-354	Dec. 30.15	Dec. 29.16
Biolog Antenna	Teveq	CBL 6111D	27089	Jun. 25.15	Jun. 24.16
Signal Amplifier	Agilent	8447D	2844A10488	Jun. 25.15	Jun. 24.16
Signal Amplifier	Agilent	8447D	2844A11174	Jun. 25.15	Jun. 24.16
10m Semi-anechoic Chamber	CHANGLING	21.4m*12.1m*8.8m	NSEMC006	Jun. 10.15	Jun. 09.16
Test Software	ADT	ADT_Radiated_V 8.7.x	N/A	N/A	N/A

Conducted Emission

Equipment	Manufacturer	Model No.	Serial No.	Last Cal.	Next Cal.
EMI Test Receiver	Rohde&Schwarz	ESCS30	100199	May 11.15	May 10.16
Pulse Limiter	Rohde&Schwarz	ESH3-Z2	100168	Oct. 12.15	Oct. 11.16
Artificial Mains Network	Rohde&Schwarz	ESH2-Z3	100071	April 25.15	April 24.16
Voltage probe	SCHWARZBECK	TK 9421	TK 9421-176	Jan. 08.16	Jan. 07.17
Test software	ADT	ADT_Cond_V 7.3.7	N/A	N/A	N/A

Harmonics/ Flicker

Equipment	Manufacturer	Model no.	Serial No.	Last Cal.	Next Cal.
PRECISION POWER ANALYZER	YOKOGAWA	WT3000	91M210852	Mar. 11.15	Mar. 10.16
Test Software	YOKOGAWA	IEC61000	N/A	N/A	N/A
REFERENCE IMPEDANCE NETWORK	Voltech	EUR	3018	Mar. 11.15	Mar. 10.16

Electro Static Discharge

Equipment	Manufacturer	Model No.	Serial No.	Last Cal.	Next Cal.
ESD Generator	TESEQ	NSG 437	279	Feb. 03.15	Feb. 02.16
Test Software	TESEQ	V03.03	N/A	N/A	N/A
ESD Generator	EM TEST	Dito	V1211112265	Aug. 08.15	Aug. 07.16
Test Software	EM TEST	V 2.31	N/A	N/A	N/A

STC (Dongguan) Company Limited

88 Famin Nan Road, Daling, Dongguan, China. (Zip Code: 523 770)
Tel.: (86 769) 8111 9668 Fax: (86 769) 8111 0323 E-mail: dgstc@dgstc.org Homepage: www.dgstc.org
This report shall not be reproduced unless with prior written approval from STC (Dongguan) Company Limited.
For Conditions of Issuance of this test report, please refer to the coverleaf or Homepage.



STC Test Report

Date: 2016-02-01
No.: DM122441

APPENDIX A

Page A2 of A3

Radiated Immunity

Equipment	Manufacturer	Model No.	Serial No.	Last Cal.	Next Cal.
Signal Generator	Agilent	N19181A	MY50142530	Oct. 12.15	Oct. 11.16
Bilog Antenna	Tesla	CBL 6111D	27089	Jun. 25.15	Jun. 24.16
Antenna Log-Periodic	CORAD	ATS700M11G	0336821	N/A	N/A
Switch Controller	CORAD	SC1000	0337343	N/A	N/A
RF Power Meter	ESE	4242	13984	Nov. 09.15	Nov. 08.16
Power Sensor	ESE	51011EMC	35716	Nov. 09.15	Nov. 08.16
Power Sensor	ESE	51011EMC	35715	Nov. 09.15	Nov. 08.16
E-Field probe	Narda	NBM-520	2403/01B	May 28.15	May 27.16
Power Amplifier	TESEQ	CBA 1G-150	T44029	N/A	N/A
Power Amplifier	TESEQ	CBA 3G-100	T44030	N/A	N/A
Power Amplifier	TESEQ	CBA 6G-050	1041204	N/A	N/A
Dual Directional Coupler	TESEQ	C5982	95208	Nov. 09.15	Nov. 08.16
Dual Directional Coupler	TESEQ	C6187	95175	Nov. 09.15	Nov. 08.16
Dual Directional Coupler	TESEQ	CPH-274F	M251304-01	Nov. 09.15	Nov. 08.16
Test Software	ADT	BVADT_RS_V7.6 +DG	N/A	N/A	N/A

Electrical Fast Transients

Equipment	Manufacturer	Model No.	Serial No.	Last Cal.	Next Cal.
EFT Tester	HAEFELY	PEFT4010	150546	May 11.15	May 10.16
EFT Coupling Clamp	HAEFELY	IP4A	150407	May 11.15	May 10.16
Test Software	HAEFELY	SWPE4010 1.22	N/A	N/A	N/A

Surge Immunity

Equipment	Manufacturer	Model No.	Serial No.	Last Cal.	Next Cal.
Combination Module	TESEQ AG	CDN 3061	1361	Jan. 08.16	Jan. 08.17
Telecom Surge Module	TESEQ AG	NSG 3060 Mainframe	1404	Jan. 08.16	Jan. 08.17
CDN	TESEQ	CDN HSS-2	34275	Nov. 13.15	Nov. 12.16
CDN	TESEQ	CDN 118	30741	Nov. 13.15	Nov. 12.16
Test Software	TESEQ	CDM 3061 0002.30	1361	N/A	N/A
Test Software	TESEQ	HVM 3060 0002.30	293	N/A	N/A

Continuous RF Immunity

Equipment	Manufacturer	Model No.	Serial No.	Last Cal.	Next Cal.
Signal Generator	Rohde&Schwarz	SMEO6	829498/006	Oct. 12.15	Oct. 11.16
CDN	Luthi	L-801M2/M3	2015	Sep. 09.15	Sep. 08.16
CDN(AUX)	TESEQ	CDN M016	27452	Nov. 13.15	Nov. 12.16
CDN	TESEQ	T200A	26944	Apr. 07.15	Apr. 06.16
CDN	TESEQ	T400A	26536	Apr. 07.15	Apr. 06.16
CDN	TESEQ	ST08A	32256	Apr. 07.15	Apr. 06.16
6dB 50Watt Attenuator	HUBER-SUHNER	3906.17.0005	303688	Oct. 12.15	Oct. 11.16
Signal Amplifier	HAEFELY	PAMP250	149594	N/A	N/A
Electromagnetic Injection Clamp	Luthi	EM101	35640	Sep. 09.15	Sep. 08.16
C/S Test System	HAEFELY	WinPAMP	NSEM002	N/A	N/A
Test Software	ADT	BVADT_CS_V7.5.1	N/A	N/A	N/A

STC (Dongguan) Company Limited

88 Panxin Nan Road, Dongguan, Dongguan, China. (Zip Code: 523770)
Tel: +86 769 8111 9666 Fax: +86 769 8111 0222 E-mail: dgtd@sgtd.org Homepage: www.sgtd.org
This report shall not be reproduced unless with prior written approval from STC (Dongguan) Company Limited.
For Conditions of Issuance of this test report, please refer to the coverlet or Homepage.



STC Test Report

Date: 2016-02-01
No.: DM122441

APPENDIX A

Page A3 of A3

Power Frequency Magnetic Field Immunity

Equipment	Manufacturer	Model No.	Serial No.	Last Cal.	Next Cal.
Magnetic Field Tester	HAEFELY	MAG100.1	150579	Oct. 12, 15	Oct. 11, 16
Test Software	N/A	N/A	N/A	N/A	N/A

Voltage Dips and Short Interruptions Immunity

Equipment	Manufacturer	Model No.	Serial No.	Last Cal.	Next Cal.
DIPS Tester	HAEFELY	PLINE 1610	150370	May 15, 15	May 14, 16
3Kva ac Power Source	California Instruments	5001ix-400	55194	April 8, 15	April 7, 16
Harmonic Flicker Test System	California Instruments	PACS-3	72134	April 8, 15	April 7, 16

Damped Oscillatory Wave Immunity

Equipment	Manufacturer	Model No.	Serial No.	Last Cal.	Next Cal.
Ringwave generator test system	EM TEST	OCS500N6	1404	Jan. 15, 16	Jan. 14, 17

Low Frequency Conduction Harassment Immunity

Equipment	Manufacturer	Model No.	Serial No.	Last Cal.	Next Cal.
Function generator	Agilent	33521A	MY50004592	Mar. 04, 15	Mar. 03, 16
Audio amplifier	AE Teihm	7224	7224-0712-0363	Mar. 04, 15	Mar. 03, 16
Voltmeter	Agilent	34401A	MY47063245	Feb. 25, 15	Feb. 24, 16
Audio coupling transformer	Solar	6220-1A	EMC201301	Feb. 25, 15	Feb. 24, 16

Remark:
N/A Not Applicable

STC (Dongguan) Company Limited

88 Fumin Nan Road, Daling, Dongguan, China. (Zip Code: 523770)
Tel: (+86 769) 8111 9066 Fax: (+86 769) 8111 6222 E-mail: dgstc@cgpb.org Homepage: www.dgpb.org
This report shall not be reproduced unless with prior written approval from STC (Dongguan) Company Limited.
For Conditions of Issuance of this test report, please refer to the overleaf or Homepage.



STC Test Report

Date: 2016-02-01
No.: DM122441

APPENDIX B

Page B1 of B9

PHOTOGRAPH (S) OF PRODUCT

View of The Product



View of The Product

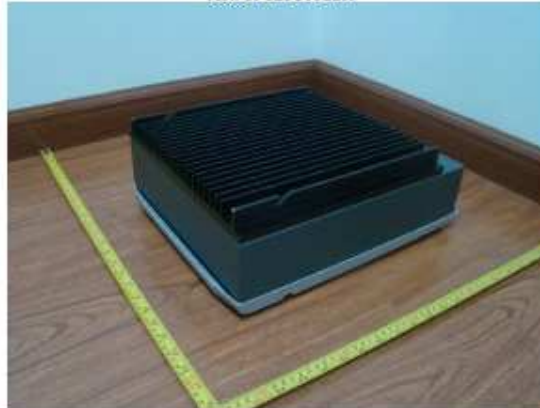

STC (Dongguan) Company Limited

88 Fanyin Nan Road, Daxing, Dongguan, China. (Zip Code: 523 770)
Tel: (86 768) 8111 9666 Fax: (86 768) 8111 0222 E-mail: dgstc@dgstc.org Homepage: www.dgstc.org
This report shall not be reproduced unless with prior written approval from STC (Dongguan) Company Limited.
For Conditions of issuance of this test report, please refer to the overleaf or Homepage.



STC Test Report

Date: 2016-02-01
No.: DM122441

APPENDIX B

Page B2 of B9

PHOTOGRAPH (S) OF PRODUCT

View of The Product



Inside View of The Product



STC (Dongguan) Company Limited

88 Fanzhi Nan Road, Daling, Dongguan, China. (Zip Code: 523 770)
Tel: (86 769) 8111 9666 Fax: (86 769) 8111 0222 E-mail: dgstc@dgstc.org Homepage: www.dgstc.org
This report shall not be reproduced unless with prior written approval from STC (Dongguan) Company Limited.
For Conditions of Issuance of this test report, please refer to the coverleaf or Homepage.



STC Test Report

Date: 2016-02-01
No.: DM122441

APPENDIX B

Page B3 of B9

PHOTOGRAPH (S) OF PRODUCT

Inner Circuit View



Inner Circuit View

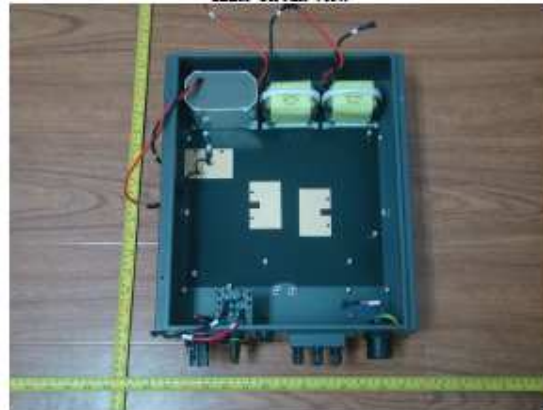

STC (Dongguan) Company Limited

88 Fanyin Road, Daling, Dongguan, China. (Zip Code: 523 770)
Tel: (86 769) 8111 9666 Fax: (86 769) 8111 0222 E-mail: dgsts@dgsts.org Homepage: www.dgsts.org
This report shall not be reproduced unless with prior written approval from STC (Dongguan) Company Limited.
For Conditions of issuance of this test report, please refer to the coverleaf or homepage.



STC Test Report

Date: 2016-02-01
No.: DM122441

APPENDIX B

Page B4 of B9

PHOTOGRAPH (S) OF PRODUCT

Inner Circuit View



Inner Circuit View



STC (Dongguan) Company Limited

88 Fanchi Nan Road, Daling, Dongguan, China. (Zip Code: 523 770)
Tel: (86 769) 8111 9656 Fax: (86 769) 8111 8222 E-mail: dgstc@dgstc.org Homepage: www.dgstc.org
This report shall not be reproduced unless with prior written approval from STC (Dongguan) Company Limited.
For Conditions of Issuance of this test report, please refer to the overleaf or Homepage.



STC Test Report

Date: 2016-02-01
No.: DM122441

APPENDIX B

Page B5 of B9

PHOTOGRAPH (S) OF PRODUCT

Inner Circuit View



Inner Circuit View

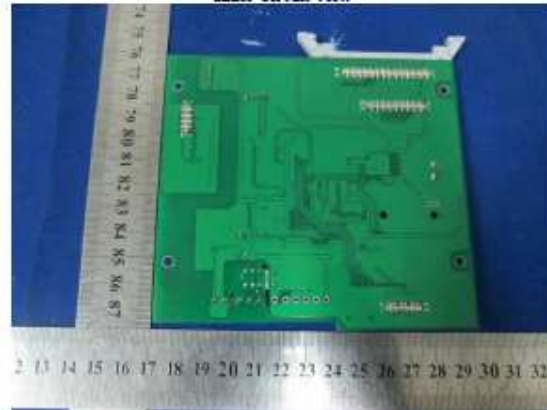

STC (Dongguan) Company Limited

88 Fanchi Nan Road, Daling, Dongguan, China. (Zip Code: 523 770)
Tel: (86 769) 8111 9666 Fax: (86 769) 8111 0222 E-mail: dgstc@dgstc.org Homepage: www.dgstc.org
This report shall not be reproduced unless with prior written approval from STC (Dongguan) Company Limited.
For Conditions of Issuance of this test report, please refer to the overleaf or Homepage.



STC Test Report

Date: 2016-02-01
No.: DM122441

APPENDIX B

Page B6 of B9

PHOTOGRAPH (S) OF PRODUCT

Inner Circuit View



Inner Circuit View



STC (Dongguan) Company Limited

88 Fanchi Nan Road, Daling, Dongguan, China. (Zip Code: 523 770)
Tel: (86 769) 8111 9656 Fax: (86 769) 8111 8222 E-mail: dgstc@dgstc.org Homepage: www.dgstc.org
This report shall not be reproduced unless with prior written approval from STC (Dongguan) Company Limited.
For Conditions of Issuance of this test report, please refer to the overleaf or Homepage.



STC Test Report

Date: 2016-02-01
No.: DMI22441

APPENDIX B

Page B7 of B9

PHOTOGRAPH (S) OF PRODUCT

Inner Circuit View



Inner Circuit View



STC (Dongguan) Company Limited

88 Fanzhi Nan Road, Daling, Dongguan, China. (Zip Code: 523 770)
Tel: (86 769) 8111 9606 Fax: (86 769) 8111 0222 E-mail: dgsts@dgsts.org Homepage: www.dgsts.org
This report shall not be reproduced unless with prior written approval from STC (Dongguan) Company Limited.
For Conditions of Issuance of this test report, please refer to the cover sheet or Homepage.



STC Test Report

Date: 2016-02-01
No.: DM122441

APPENDIX B

Page B8 of B9

PHOTOGRAPH (S) OF PRODUCT

Inner Circuit View



Inner Circuit View



STC (Dongguan) Company Limited

88 Fushan Nan Road, Daling, Dongguan, China. (Zip Code: 523 770)
Tel: (86 769) 8111 9666 Fax: (86 769) 8111 0323 E-mail: dgstc@dgstc.org Homepage: www.dgstc.org
This report shall not be reproduced unless with prior written approval from STC (Dongguan) Company Limited.
For Conditions of Issuance of this test report, please refer to the overleaf or Homepage.



STC Test Report

Date: 2016-02-01
No.: DM122441

APPENDIX B

Page B9 of B9

PHOTOGRAPH (S) OF PRODUCT

Inner Circuit View



STC (Dongguan) Company Limited

88 Fumin Nan Road, Daling, Dongguan, China. (Zip Code: 523 770)
Tel: (86 769) 8111 9066 Fax: (86 769) 8111 8222 E-mail: dg@stc.org Homepage: www.dg@stc.org
This report shall not be reproduced unless with prior written approval from STC (Dongguan) Company Limited.
For Conditions of issuance of this test report, please refer to the overleaf or Homepage.

Annex 2

Pictures of the unit

Enclosure front view



Enclosure rear view



Enclosure bottom view



Internal view-1

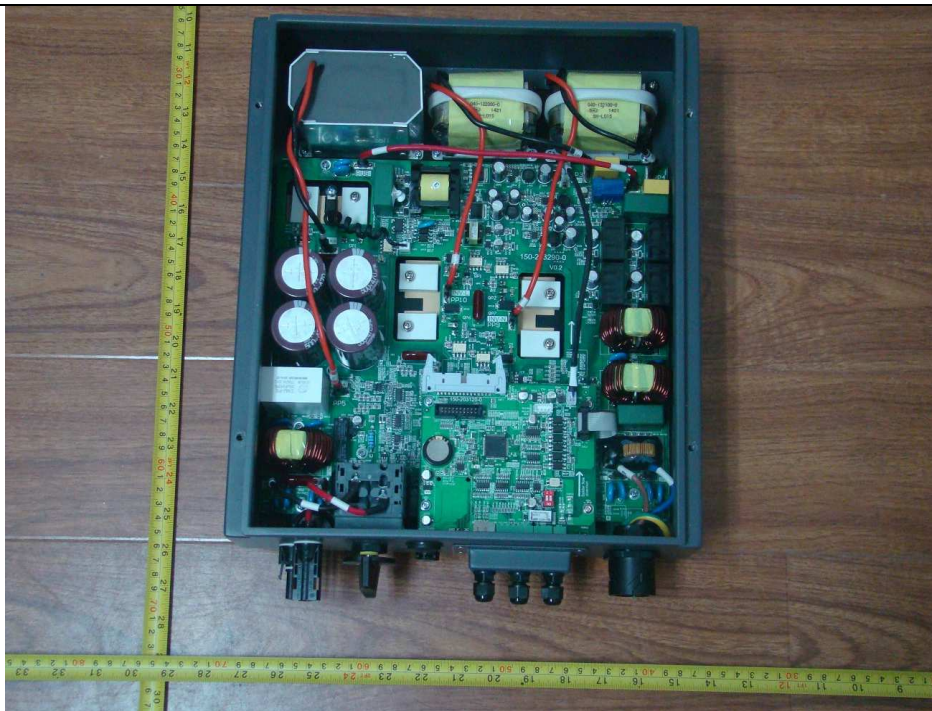

Internal view-2



Internal view-3

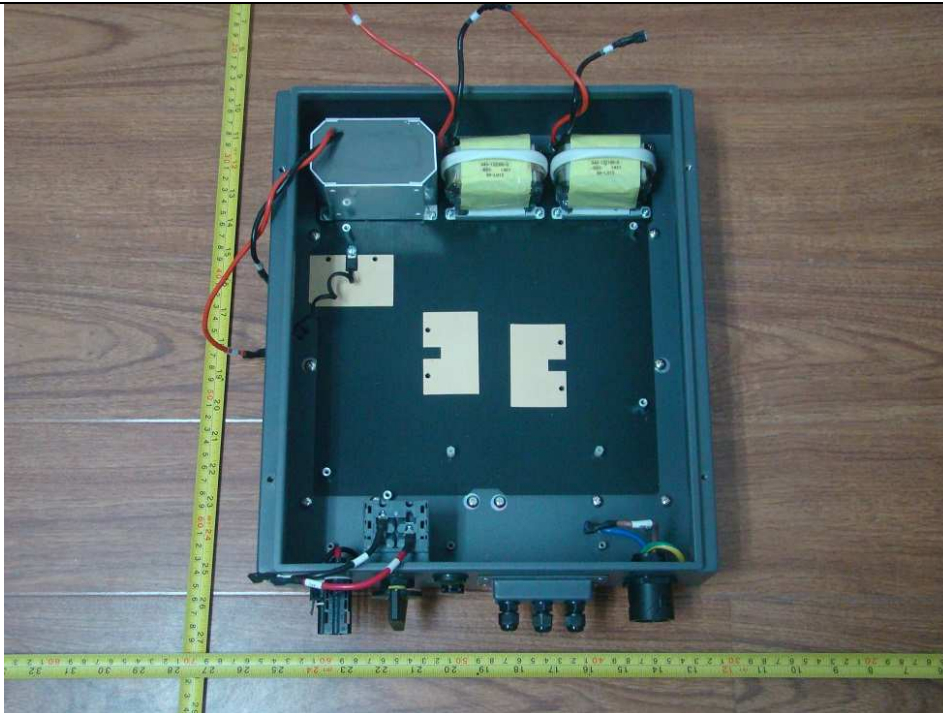

Internal view-4



Main power board component side view



Main power board solder side view



Control board component side view

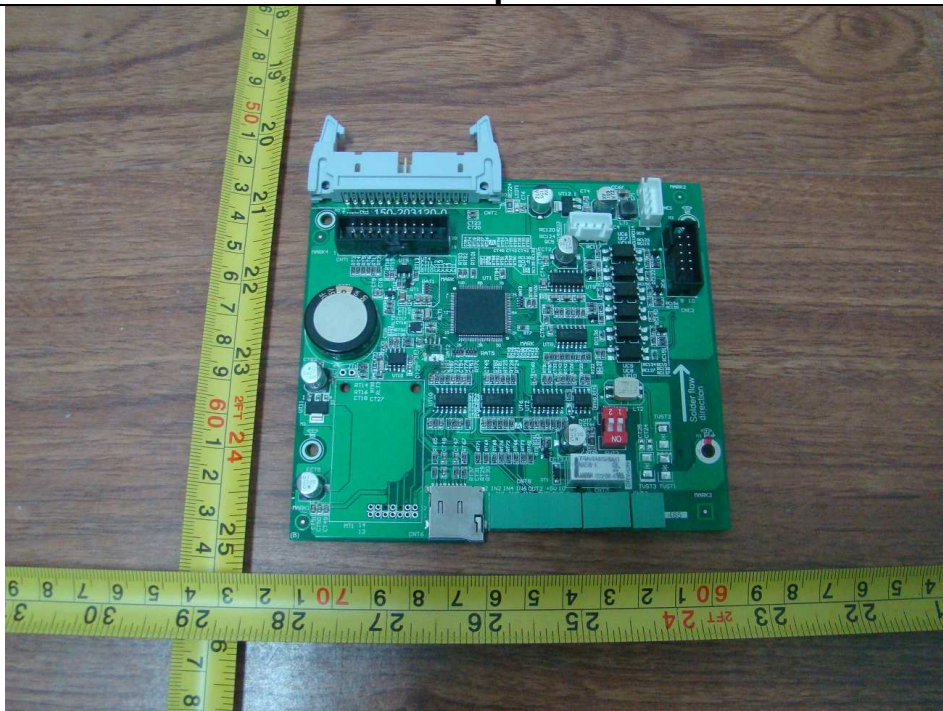

Control board solder side view

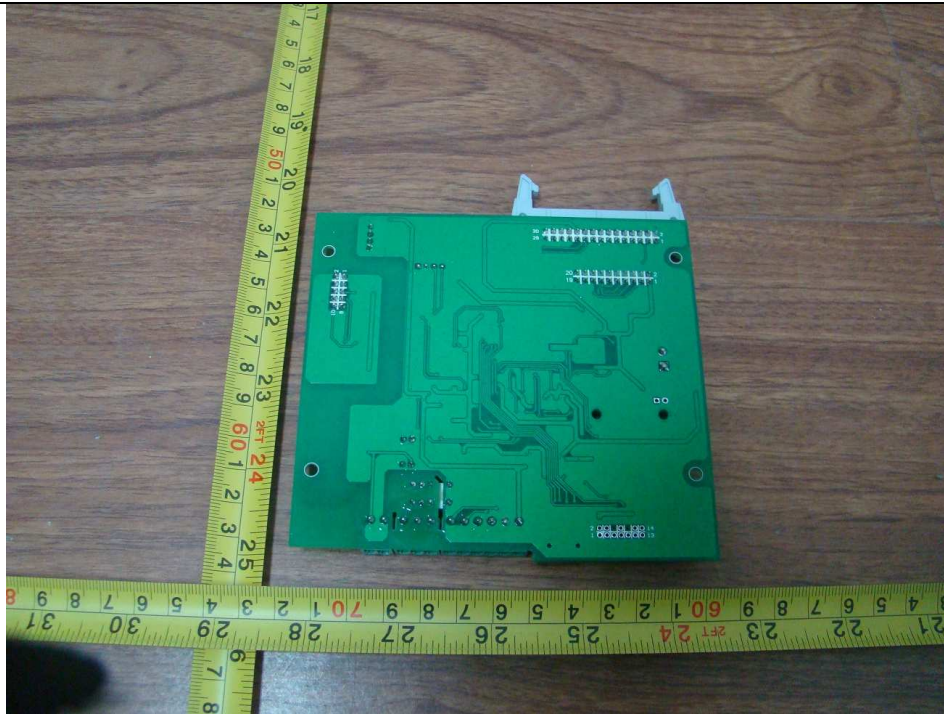

Display board component side view

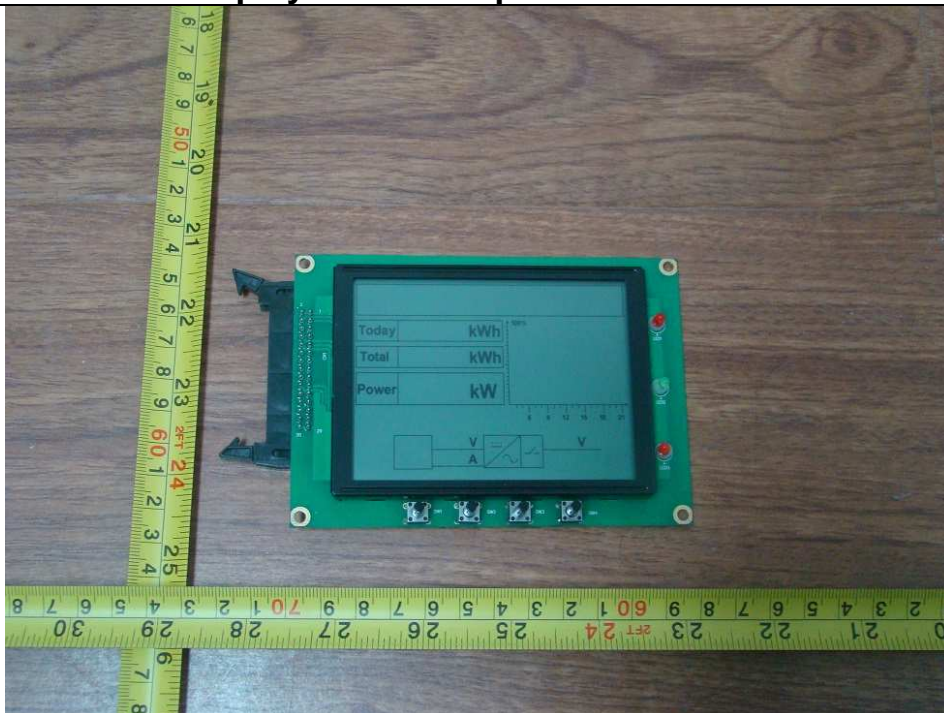

Display board solder side view

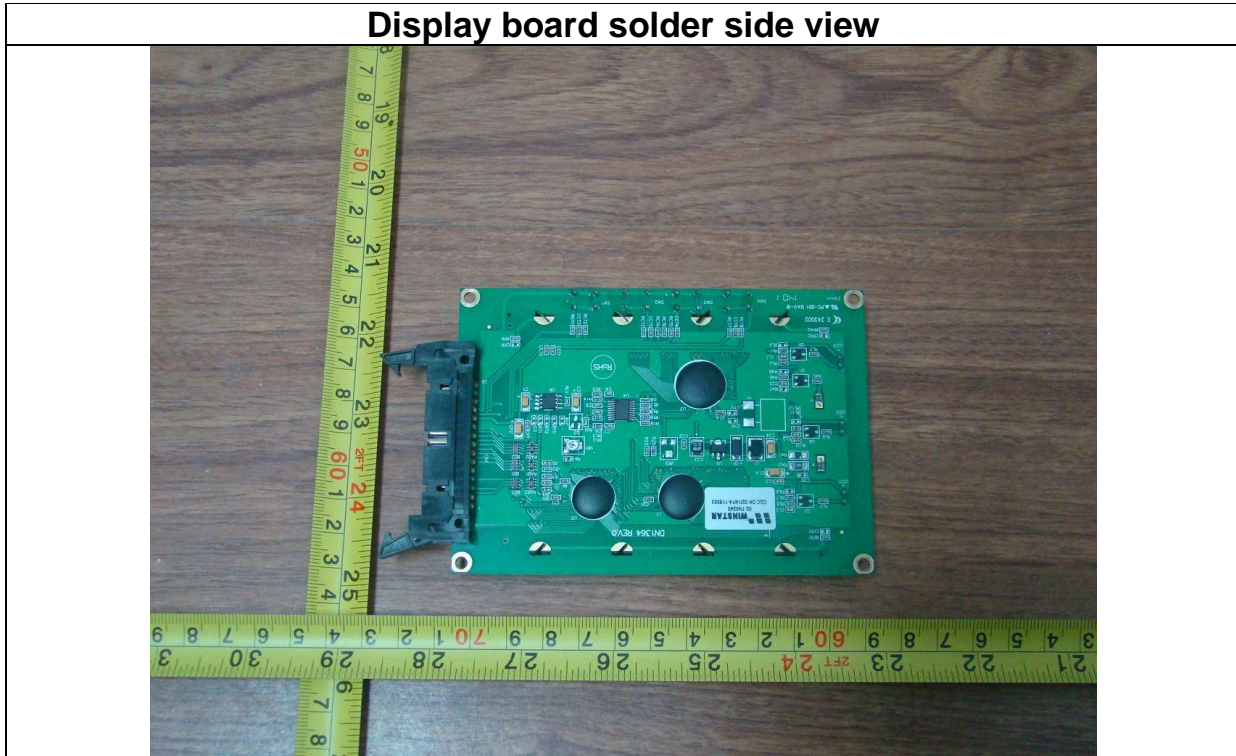

Annex 3

Test equipment list

Test location: Bureau Veritas Shenzhen Co., Ltd. Dongguan Branch
Performed dates of test: 2016-07-21 till 2016-08-31

Equipment	Internal No.	Manufacturer	Type	Serial No.	Last Calibration
Power Analyzer	A4080002DG	YOKOGAWA	WT3000	91M210852	Mar. 07, 2016
AC Source	A7040019DG	Chroma	61512	61512000439	Monitored by Power Analyzer
AC Source	A7040020DG	Chroma	61512	61512000438	Monitored by Power Analyzer
DC Simulation Power Supply	A7040015DG	Chroma	62150H-1000S	62150EF00488	Monitored by Power Analyzer
DC Simulation Power Supply	A7040016DG	Chroma	62150H-1000S	62150EF00490	Monitored by Power Analyzer
DC Simulation Power Supply	A7040017DG	Chroma	620028	620028EF00120	Monitored by Power Analyzer
RLC Load	A7150027DG	Qunling	ACLT-3803H	93VOO2869	Monitored by Power Analyzer
ScopeCorder	A4089017DG	YOKOGAWA	DL850-H-HC	91N726247	Sep. 11, 2015
Isolation voltage probe	A1490008DG	YOKOGAWA	701901	//	Oct. 21, 2015
Isolation voltage probe	A1490009DG	YOKOGAWA	701901	//	Oct. 29, 2015
Current transducer	A1060007DG	YOKOGAWA	CT200	1130700012	Jan. 20, 2016
Current transducer	A1060007DG	YOKOGAWA	CT200	1130700012	Dec. 01, 2015
Current transducer	A1060008DG	YOKOGAWA	CT200	1130700017	Nov. 16, 2015
Current transducer	A1060009DG	YOKOGAWA	CT200	1130700019	Nov. 16, 2015
LCR Hitester	A1060006DG	HIOKI	3535	120112505	Mar. 06, 2016